



Instruction Manual

iGen4750s
Inverter Generator



CONGRATULATIONS ON PURCHASING A WESTINGHOUSE INVERTER GENERATOR

Thank you for purchasing a Westinghouse inverter generator. It is a high-quality power product that will provide many years of safe and reliable service if properly operated and maintained.

DANGER



This manual contains important instructions for operating the generator. For your safety and that of others, be sure to read this manual thoroughly before operating the generator. Failure to properly follow all instructions and precautions could cause you or others to be seriously hurt or killed. This manual should be considered a permanent part of the generator and should remain with it if resold.

For Your Records

Date of Purchase: _____ Generator Model Number: _____

Purchased From: _____ Generator Serial Number: _____

Purchase Receipt: Please retain your tax invoice or purchase receipt to ensure warranty coverage.

DISCLAIMERS

All instructions, illustrations and specifications in this manual are based on the latest information available at the time of publishing. The illustrations used in this manual are intended as representative reference views only. Moreover, because of our continuous product improvement policy, we may modify information, illustrations or specifications to explain or exemplify a product, service or maintenance improvement. We reserve the right to make any change at any time without notice. Your generator may differ slightly from the models pictured, including optional accessories.

ALL RIGHTS RESERVED

No part of this publication may be reproduced or used in any form by any means – graphic, electronic or mechanical, including photocopying, recording, taping or information storage and retrieval systems – without the written permission of Westinghouse Outdoor Power Equipment.

UPDATES

The latest Instruction Manual for your Westinghouse inverter generator can be found under the Downloads tab on our website at www.westinghouseoutdoorpower.com.au

CONTENTS

SAFETY	1
SAFETY DEFINITIONS	1
SAFETY SYMBOLS	1
GENERAL SAFETY RULES.....	2
SAFETY LABELS.....	5
UNPACKING	6
UNPACKING THE GENERATOR	6
ACCESSORIES.....	6
FEATURES	7
MAIN GENERATOR COMPONENTS	7
CONTROL PANEL FEATURES	8
OPERATION	10
CONNECTING THE BATTERY	10
BEFORE STARTING THE GENERATOR	11
CHECKING OR ADDING ENGINE OIL AND FUEL	12
Checking and Adding Engine Oil	12
Checking and Adding Fuel.....	12
STARTING THE GENERATOR.....	13
ELECTRIC STARTING	13
MANUAL STARTING	14
WIRELESS REMOTE STARTING	15
PAIRING THE REMOTE CONTROL FOB AND GENERATOR	15
ECO THROTTLE CONTROL	15
OVERLOAD RESET	16
STOPPING THE GENERATOR.....	16
Normal Operation	16
During an Emergency.....	16
APPLICATION AND DUTY CYCLE.....	16
AMBIENT CONDITIONS.....	16
CONNECTING ELECTRICAL LOADS	17
240-Volt AC Loads.....	17
12-Volt DC Loads.....	17
Power Output and Demand	17
240-VOLT AC EXTENSION CORDS.....	18
12 VOLT BATTERY CHARGING	19
Battery Charging by Direct Connection	19
Battery Charging by a Mains-Powered Charger.....	19
TRANSPORTING THE GENERATOR	20

MAINTENANCE	21
MAINTENANCE PRECAUTIONS	21
MAINTENANCE SCHEDULE	21
ENGINE OIL	22
Engine Oil Specification	22
Checking Engine Oil	22
Adding Engine Oil	22
Changing Engine Oil.....	23
AIR FILTER	24
Cleaning the Air Filter	24
12 VOLT BATTERY	24
Charging the Battery	25
Replacing the Battery.....	25
FUEL STRAINER	26
Cleaning the Fuel Strainer	26
SPARK PLUG	26
Cleaning and Replacing the Spark Plug	26
SPARK ARRESTOR	28
Cleaning the Spark Arrestor.....	28
REPLACING THE FUEL FILTER	28
CHECKING AND ADJUSTING THE VALVE CLEARANCE	29
MAINTENANCE ACCESS	30
CLEANING THE GENERATOR	31
DRAINING THE FUEL	31
LONG-TERM STORAGE	32
Storage Procedure for 1 – 3 Months	32
Storage Procedure for Greater than 3 Months.....	32
Removal from Storage	32
DISMANTLING AND DISPOSAL	33
TROUBLESHOOTING	34
SPECIFICATIONS	39
WIRING DIAGRAM	40
WARRANTY	41
WARRANTY AGAINST DEFECTS	41
Proof of Purchase	41
Warranty Conditions	41

SAFETY

SAFETY DEFINITIONS

The words DANGER, WARNING, CAUTION and NOTICE are used throughout this manual to highlight important information. Be certain that the meanings of these alerts are known to all who work on or near the equipment.



This safety alert symbol appears with most safety statements. It means attention, become alert, your safety is involved! Please read and abide by the message that follows the safety alert symbol.

DANGER

Indicates a hazardous situation which, if not avoided, will result in death or serious injury.

WARNING

Indicates a hazardous situation which, if not avoided, could result in death or serious injury.

CAUTION

Indicates a hazardous situation which, if not avoided, could result in minor or moderate injury.

NOTICE

Indicates a situation which, if not avoided, could cause damage to the generator, personal property or the environment, or cause the equipment to operate improperly.

NOTE: Indicates a procedure, practice or condition that should be followed in order for the generator to function in the manner intended.



SAFETY SYMBOLS

Symbol	Description
	Safety Alert Symbol
	Asphyxiation Hazard
	Burn Hazard

Symbol	Description
	Burst / Pressure Hazard
	Electrical Shock Hazard
	Explosion Hazard
	Fire Hazard
	Lifting Hazard
	Pinch-Point Hazard
	Button/Coin Battery Hazard
	Don't Leave Tools Around
	Keep Away From Fire
	Keep Dry
	Do Not Drop
	Do Not Dump
	Read Manufacturer's Instructions
	Wear Personal Protective Equipment (PPE)
	Read Safety Messages Before Proceeding
	Please Recycle

GENERAL SAFETY RULES

 DANGER	
	Never use the generator in a location that is wet or damp. Never expose the generator to rain, snow, water spray or standing water while in use. Protect the generator from all hazardous weather conditions. Moisture or ice can cause a short circuit or other malfunction in the electrical system.
	Never operate the generator in an enclosed area. Engine exhaust contains carbon monoxide. Only operate the generator outside and away from windows, doors and vents.
	Never use or store the generator in any area exposed to rain, snow or other moisture. Never immerse the generator in water or any other liquid.
	Never place the generator close to or in a fire or expose it to extreme heat. Keep out of direct sunlight if possible and safe to do so.
	Never dispose of the battery together with household waste.
	Recycle or dispose of the battery properly.

 WARNING	
	<p>Voltage produced by the generator could result in death or serious injury.</p> <ul style="list-style-type: none"> • Never operate the generator in rain or a floodplain unless proper precautions are taken to avoid being subject to rain or flood. • Never use worn or damaged extension cords. • Always have a licensed electrician connect the generator to any fixed electrical installation. • Never touch an operating generator if the generator is wet or if you have wet hands. • Never operate the generator in highly conductive areas such as around metal decking or steel works. • Always use earthed extension cords. Always use three-wire or double-insulated power tools. • Never touch live terminals or bare wires while the generator is operating. • Keep animals and children away from the generator at all times.

⚠️ WARNING



Petrol fuel liquid and vapours are extremely flammable and explosive under certain conditions.



- Always refuel the generator outdoors, in a well-ventilated area.
- Never remove the fuel cap while the engine is running.
- Never refuel the generator while the engine is running. Always turn engine off and allow the generator to cool before refuelling.
- Only fill fuel tank with unleaded petrol.
- Keep away from sparks, open flames or other forms of ignition such as matches, cigarettes, CB radios and mobile phones when refuelling.
- Never overfill the fuel tank. Leave room for fuel to expand. Overfilling the fuel tank can result in a sudden overflow of fuel and result in spilled fuel coming in contact with hot surfaces. Spilled fuel can ignite. If fuel is spilled on the generator, wipe it up immediately and dispose of rags properly. Allow area of spilled fuel to dry before operating the generator.
- Wear eye protection while refuelling.
- Never use fuel as a cleaning agent.
- Store any fuel containers in a well-ventilated area, away from any combustibles or source of ignition.
- Check for fuel leaks after refuelling. Never operate the engine if a fuel leak is discovered.
- Equip the operating area with a Class ABE or BE portable fire extinguisher.

⚠️ WARNING



Never operate the generator if: powered items overheat; electrical output drops; there are sparks, flames or smoke coming from the generator; or if the receptacles are damaged.



Never attempt to connect more than one generator or other electrical energy source (e.g. mains power supply, solar power system, battery and inverter power system, etc.) concurrently to the same electrical device, extension cord or fixed electrical installation.



Never use the generator to power medical support equipment.



Always remove any tools or other service equipment used during maintenance before operating the generator.

⚠️ WARNING



Never operate in a hazardous location, e.g. where there may be a risk of explosion of petrol fumes, leaking gas or explosive dusts.



Never operate in a confined area where exhaust gases, smoke or fumes could reach dangerous concentrations.



Never refuel while engine is running.

⚠ WARNING



The generator may be started accidentally by remote control if left unintentionally with its battery switch in the ON position.

- Always keep the remote control fob secure to prevent accidental starting of the generator.
- Never leave the generator in non-operating standby mode with the battery switch ON unless intentionally required.
- Never start the generator by remote control unless you have it in clear sight or are otherwise sure that it is safe to do so.

⚠ WARNING



The remote-control fob contains a lithium button/coin cell battery that is hazardous and should always be kept away from children. This applies whether the battery is new or used.

The battery can cause severe or fatal injuries in 2 hours or less if it is swallowed or placed inside any part of the human body.

If it is suspected that the battery has been swallowed or otherwise placed inside any part of the body, contact the Australian Poisons Information Centre by calling 13 11 26 immediately for 24/7 fast, expert advice.

⚠ WARNING



You must take reasonable care for the health and safety both of yourself and any others who may be affected by your actions. You must understand and follow all the safety rules and working instructions described herein. You must also use your own good judgement and common sense.

⚠ CAUTION



Charge the generator battery to 100% capacity immediately after purchase and thereafter at intervals of no longer than three months.



Use only the original battery charger and cables supplied with the generator.



Always keep the generator in an upright position and protected from impact or excessive vibration while being transported.

NOTICE

Never modify the generator.









Never operate the generator if it vibrates at high levels, if the engine speed changes greatly or if the engine misfires often.

Always disconnect or switch off electric tools or appliances from the generator before starting.

SAFETY

SAFETY LABELS

The safety labels have specific positions and must be replaced if they are unreadable, damaged or missing.

⚠ DANGER		⚠ WARNING	
	The electrical output of this generator is potentially lethal. It should not be connected to a fixed electrical installation except by an appropriately licensed person.		Read Instruction Manual
	Engine exhaust contains poisonous carbon monoxide. Do not operate the generator in a confined space. Use it only outside and far away from windows, doors and vents.		Unleaded Petrol Only
	Do not operate the generator in a hazardous location where flammable or explosive liquids, gases or dusts may be present.	 Westinghouse Westinghouse Outdoor Power Equipment 777 Manor Park Drive Columbus 43228 Ohio USA www.westinghouse.net.au	
	Petrol is highly flammable. Keep it away from sparks, flames and other sources of ignition. Do not refuel the generator while engine is running.		
			Made in PRC

⚠ WARNING

 The remote-control fob contains a lithium button/coin cell battery that is hazardous and should always be kept away from children. This applies whether the battery is new or used.

 The battery can cause severe or fatal injuries in 2 hours or less if it is swallowed or placed inside any part of the human body.

If it is suspected that the battery has been swallowed or otherwise placed inside any part of the body, contact the Australian Poisons Information Centre by calling 13 11 26 immediately for 24/7 fast, expert advice.



Figure 1 - Safety Labels

UNPACKING THE GENERATOR

⚠ WARNING



Always have assistance when lifting the generator. The generator is heavy; lifting it could cause bodily harm.



Avoid cutting on or near staples to prevent personal injury.

1. Carefully cut the packing tape on top of the carton.
2. Fold back top flaps to reveal the upper packing tray.
3. Remove and save the accessories.
4. Remove and discard the upper packing tray.
5. Unfold the top of the plastic bag enclosing the generator.
6. Lift the generator out of the plastic bag and carton.
7. Recycle or dispose of the packaging materials properly.

ACCESSORIES

Check the accessories against those shown in Figure 2. If any parts are missing, please contact your local Westinghouse dealer.

A – Bottle of SAE 10W-30 Engine Oil
(600 ml for iGen4750s)

B – Spark Plug Socket Wrench

C – Double-Ended Screwdriver

D – Oil Funnel

E – Instruction Manual

F – Battery Charger

G – Remote Control Fob



Figure 2 - Accessories

FEATURES

MAIN GENERATOR COMPONENTS



- 1 - Carry Handle
- 2 - Fuel Cap and Vent
- 3 - Control Panel
- 4 - Panel Lights
- 5 - Inlet Ventilation Grille
- 6 - Extendable Handle
- 7 - Recoil Starter Handle
- 8 - LHS Maintenance Access Cover
- 9 - Wheel
- 10 - LHS Access Cover Lock
- 11 - Fuel Control Switch
- 12 - Device Charging Tray (Non-Magnetic)
- 13 - Muffler Access Cover
- 14 - Outlet Ventilation Grille
- 15 - Exhaust Pipe
- 16 - RHS Access Cover Lock
- 17 - RHS Maintenance Access Cover
- 18 - Spark Plug Access Cover
- 19 - Remote Control Fob Storage

Figure 3 - iGen4750s Main Generator Components

CONTROL PANEL FEATURES

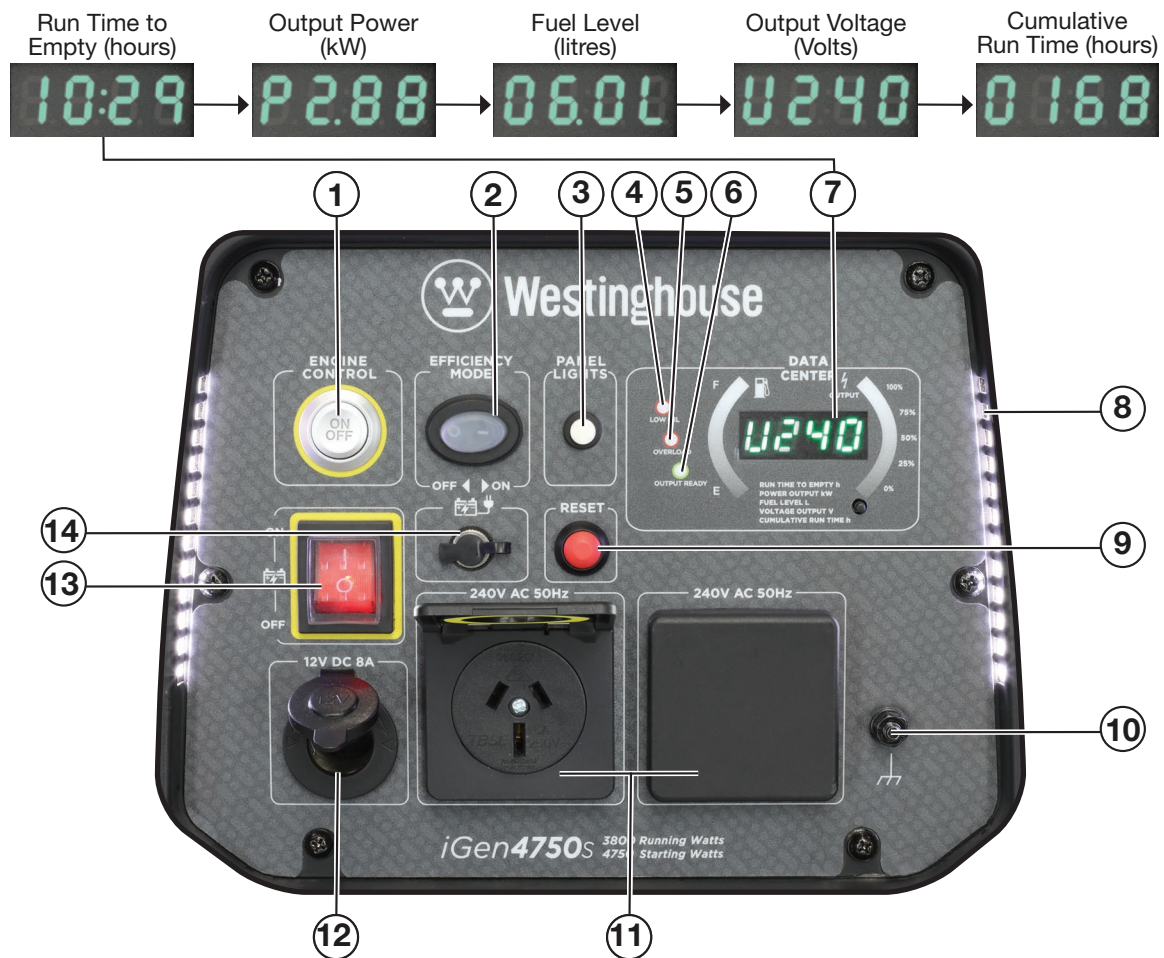

Figure 4 - iGen4750s Control Panel Features

- 1. Engine Control Button:** When the battery switch is in the ON position and illuminated red, press and release the engine control button to start or stop the generator.
- 2. ECO Throttle Switch:** Push the switch to the ON position when powering small resistive loads such as a computer or electric light; the engine speed will automatically be kept to a minimum, thereby reducing fuel consumption and noise. Select the OFF position when powering large inductive loads such as an air conditioner or electric pump; the engine speed will be kept higher for maximum electrical starting power.
- 3. Panel Lights Switch:** Press this button in fully and release to switch the panel lights on or off. The setting will be retained if the generator is stopped and restarted.
- 4. Low Oil Alarm:** The red warning light will illuminate and the engine will automatically shut down if the oil level becomes too low. Add oil to the correct level before restarting the engine.
- 5. Overload Alarm:** The red warning light will illuminate if the generator's AC output is overloaded or short-circuited. A brief small overload may be tolerated, but the connected load should be reduced. An extended large overload or short circuit will trip the overload protection feature and disconnect the generator's AC output even though the engine is still running. Reduce the connected load or rectify the electrical fault before pressing the generator reset button to restore AC output.
- 6. Output Indicator:** The green status light will illuminate whenever the engine is running and there's AC output available from the generator.

FEATURES

7. **Data Center:** The alphanumeric LED display normally shows the run time to empty based on the current output power and fuel level. This parameter is displayed automatically upon start-up. Press the button on the lower right-hand side of the data center fascia to cycle the display through the output power, fuel level, output voltage and cumulative run time values, as required, before returning to the run time to empty value. The curved LED graphic displays to the left and right of the alphanumeric display show the fuel level and output power, respectively.
8. **LED Panel Lights:** These can be switched on at any time to illuminate the control panel for your convenience and safety.
9. **Generator Reset Button:** Press and hold down this button to reset the generator's 240-Volt AC electrical output when safe to do so after reducing the applied load or rectifying the electrical fault that has caused an overload trip.
10. **Frame Terminal:** The frame terminal can be used by a licensed electrician to earth the generator if necessary.
11. **240-Volt AC, 15-Amp Outlet with Cover:** Each outlet is capable of delivering the generator's peak output of 3,750 Watts.
12. **12-Volt DC Accessory Socket with Cover:** Can be used for 12-Volt DC powered devices up to a maximum demand of 100 Watts (i.e. 8 Amps).
13. **Battery Switch:** This must be set to the ON position to enable starting of the generator either manually with the recoil starter or at the push of a button on the control panel or remote control fob. Moving the switch to the OFF position will stop the generator if running. The generator can be started or stopped by remote control whenever the battery switch is in the ON position.
14. **Battery Charging Inlet with Cover:** Connect the outlet plug from the supplied battery charger into this socket to charge the generator's battery in situ. The battery charger can be disconnected or switched off before operating the generator, if desired.

CONNECTING THE BATTERY

⚠ WARNING



To avoid electric shock:

- Always connect the positive (+) battery cable (red boot) first when connecting battery cables.
- Always disconnect the negative (-) battery cable (black boot) first when disconnecting battery cables.
- Never connect the negative (-) battery cable (black boot) to the positive (+) terminal on the battery.
- Never connect the positive (+) battery cable (red boot) to the negative (-) terminal on the battery.
- Never touch both battery terminals simultaneously.
- Never place a tool or other metal object across both battery terminals.
- Never place a tool or other metal object between either of the battery terminals and any part of the generator.
- Always use insulated or non-conducting tools when installing the battery.

NOTE: The generator comes equipped with the battery cables already attached to the battery. It is only necessary to assemble the battery wiring harness connector.

Tools required – None

1. Turn the left-hand side (LHS) access cover lock clockwise to the unlocked position (see Figure 5).



Figure 5 – LHS Access Cover Lock in the Unlocked Position

2. Grip and pull away on the left-hand side maintenance tab to open and remove the cover (see Figure 6).



Figure 6 – Removing the LHS Maintenance Access Cover

3. Check that the battery is positioned correctly and securely held in place by the battery clamp (see Figure 7). Check also that the battery cables are not kinked or pinched.

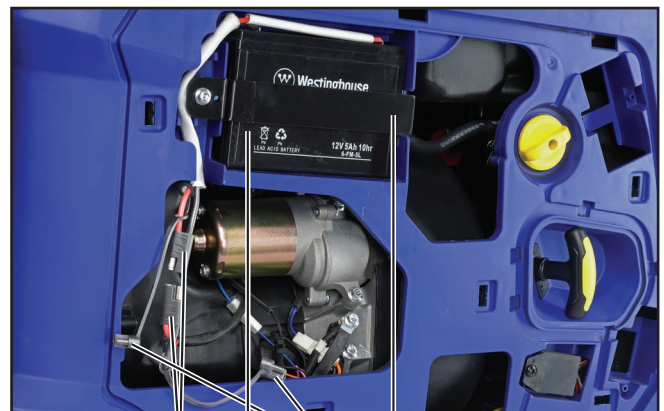

- 1 - Battery Wiring Harness Connector
- 2 - Battery
- 3 - Plug Protector
- 4 - Battery Clamp

Figure 7 – Battery Mounting Inside Generator

4. Locate the two halves of the battery wiring harness connector. Remove their protective rubber plugs and stow these away from any hot-running engine components or where they might interfere with the access cover.
5. Assemble the connector by firmly pushing the two halves together; each of the two male pins should be inserted into the corresponding female socket on the other half of the connector as shown in Figure 8. The connector should be assembled tightly with no appreciable gap left between the two halves.

OPERATION

- Before starting the generator for the first time when new or after three months of non-use, the onboard battery should be charged. See Battery Maintenance for instructions.

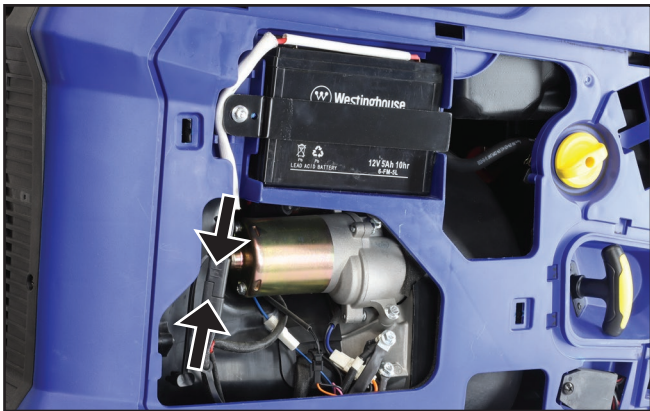

Figure 8 – Assembling the Battery Wiring Harness Connector

BEFORE STARTING THE GENERATOR

Location Selection – Before starting the generator, avoid exhaust and location hazards by verifying that:

- You have selected a location to operate the generator that is outdoors and well ventilated.
- You have selected a location with a level and solid surface on which to place the generator.
- You have selected a location that is at least 1.8 m away from any building, other equipment or combustible material.
- If the generator is located close to a building, it is not located near any windows, doors or vents.

⚠ DANGER

Using a generator indoors can kill you in minutes. Generator exhaust contains carbon monoxide. This is a poison you cannot see or smell.

Never use inside a home or garage, even if doors and windows are open.

Only use outside and far away from windows, doors and vents.

The output of this generating set is potentially lethal. The set should not be connected to a fixed electrical installation except by an appropriately licensed person.

⚠ WARNING

Always operate the generator on a level surface. Placing the generator on a non-level surface can cause the generator to tip over, causing fuel and oil to spill. Spilt fuel can ignite if it comes into contact with an ignition source such as a very hot surface.

NOTICE

Only operate the generator on a solid, level surface. Operating the generator on a surface with loose material such as sand or grass clippings can cause debris to be ingested by the generator that could:

- Block cooling vents
- Block air intake system

NOTICE

Ensure that the generator is always kept horizontal during handling, operation, storage and transport. Flipping the generator over onto its side, end or top will damage it.

Weather – Never operate or store your generator outdoors during rain, snow or any combination of weather conditions that could lead to moisture collecting on, in or around the generator.

Dry Surface – Always operate or store the generator on a dry surface free of any moisture.

No Connected Loads – It is recommended that the generator has no connected loads before starting to prevent the unintended operation of any such connected devices; this might not be practicable in all applications. To ensure there are no connected loads, either unplug any electrical cords or devices from the 240-Volt AC or 12-Volt DC accessory receptacles on the control panel or check that they are switched off.

Extensions Cords – Locate the generator in a convenient place, avoiding long extension cords and possible damage to them by pedestrians or vehicles.

Earthing the Generator – The generator's equipotential bonding system including the frame terminal on the control panel should not be connected to the general mass of earth through a separate earth electrode. For more information, refer to AS/NZS 3010:2017 Electrical Installations – Generating Sets or consult a licensed electrician.

⚠️ WARNING



Be sure the generator is properly installed to reduce the possibility of electric shock. Any connection to an electrical installation such as in a building, for example, must be carried out by a licensed electrician.

CHECKING OR ADDING ENGINE OIL AND FUEL

⚠️ DANGER



Filling the fuel tank with fuel while the generator is running can cause fuel to spill and come in contact with hot surfaces that can ignite the fuel.

Before starting the generator, always check the engine oil and fuel levels.

After starting the generator, it is not safe to add fuel to the fuel tank or engine oil to the engine while the engine is running or immediately after stopping while the engine and muffler are still hot.

Checking and Adding Engine Oil

⚠️ WARNING



Internal pressure can build up in the engine crankcase while the engine is running. Removing the oil fill plug while the engine is hot can cause hot oil to spray out of the crankcase and cause severe skin burns. Allow engine oil to cool for several minutes before removing the oil fill plug.

The generator as shipped does not contain oil in the engine. You must add engine oil before starting the generator for the first time. See Checking Engine Oil and Adding Engine Oil for instructions on checking engine oil level and the procedure for adding engine oil.

NOTICE

The generator does not contain engine oil as shipped. Attempting to start the engine before adding engine oil can permanently damage internal engine components.

Checking and Adding Fuel

⚠️ WARNING



Never refuel the generator while the engine is running. Always push the battery switch to the OFF position before refuelling.



Always turn the engine off and allow the generator to cool before refuelling.

With the generator switched off and stationary on a horizontal surface, check the fuel level in the tank visually by removing the fuel cap. It is good practice to always fill the fuel tank before operating the generator.

Required Fuel – Use only unleaded petrol with an octane rating not less than 91 and ethanol content not greater than 10%. Where possible, it is preferable to use regular or Opal unleaded petrol (RON 91) or premium unleaded petrol (RON 95 or 98) and not an ethanol blend such as E10.

Filling the Fuel Tank – Follow the steps below to fill the fuel tank:

1. Stop the generator, if running. Ensure that the battery switch is in the OFF position.
2. Allow the generator to cool down until the muffler access cover is cool to the touch.
3. Move the generator to a flat surface.
4. Clean area around the fuel cap.
5. Turn the fuel cap vent clockwise to the ON position.
6. Remove the fuel cap by unscrewing it anti-clockwise.
7. Slowly add fuel into the fuel tank. Be careful not to overfill the tank. The fuel level should NOT be higher than the red ring inside the fuel strainer (see Figure 9).

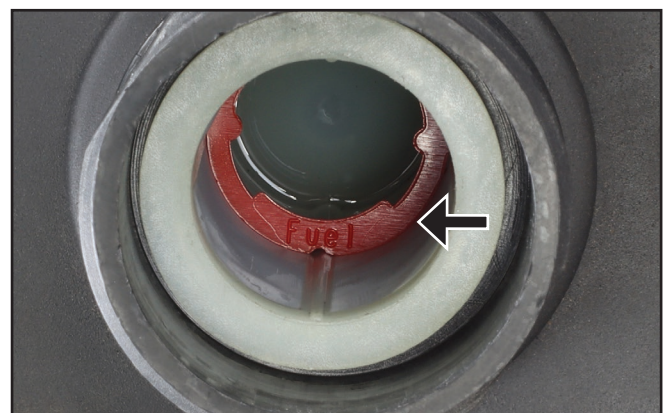

Figure 9 – Maximum Fuel Fill Level

OPERATION

- Replace the fuel cap by screwing it on clockwise and then turn the fuel cap vent anti-clockwise to the OFF position.

CAUTION



Avoid prolonged skin contact with fuel. Avoid prolonged inhalation of fuel vapours.

NOTICE

Do not overfill the fuel tank. Spilt fuel may damage some plastic parts.

STARTING THE GENERATOR

Before attempting to start the generator, verify the following:

- The engine is filled with engine oil (see Checking Engine Oil).
- The generator is situated in a proper location (see Location Selection).
- The generator is on a dry surface (see Weather and Dry Surface).
- All loads are disconnected from the generator or switched off (see No Connected Loads).
- The ECO throttle control switch is in the OFF position (see ECO Throttle Control).

DANGER



Never use the generator in a location that is wet or damp. Never expose the generator to rain, snow, water spray or standing water while in use. Protect the generator from all hazardous weather conditions. Moisture or ice can cause a short circuit or other malfunction in the electrical system.



Never operate the generator in an enclosed area. Engine exhaust contains carbon monoxide. Only operate the generator outside and away from windows, doors and vents.

NOTICE

The generator is equipped with a low oil shutdown switch. If the oil level becomes too low, the engine will shut down automatically and cannot be restarted until the oil is filled to the proper level.

Be sure the engine has the proper oil level before using. Failure to verify that the engine has the proper oil level could result in severe engine damage or shorten the engine life.

Disconnect or switch off all loads from the generator before starting. Failure to verify all loads are disconnected prior to starting the generator could result in damage to the connected electrical devices.

The primary touch points that the user needs to interact with when starting the generator are identified with yellow coloured markings.

- The first step irrespective of starting mode is to turn the fuel cap vent clockwise to the ON position (see Figure 10).



Figure 10 – Fuel Cap Vent in the ON Position

ELECTRIC STARTING

- Turn the fuel control switch anti-clockwise to the ON position (see Figure 11).

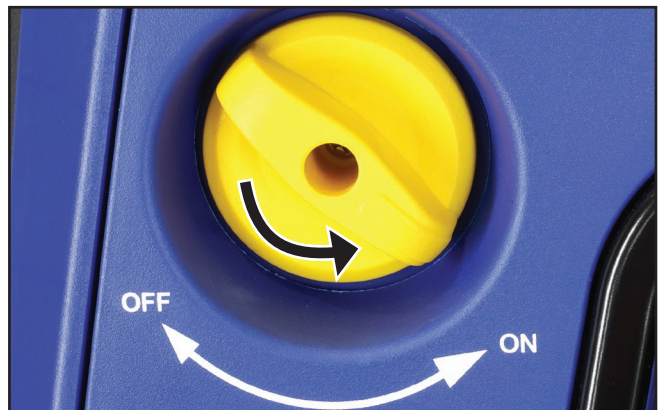

Figure 11 – Fuel Control Switch in the ON Position

2. Push the battery switch to the ON position (see Figure 12).



Figure 12 – Battery Switch in the ON Position

3. Momentarily push and release the engine control button whereupon the electric starter motor will automatically engage and start the engine (see Figure 13).



Figure 13 – Pressing the Engine Control Button

NOTICE

Failure to promptly release the engine control button will inhibit the automatic starting sequence. Momentarily push and release the button again to repeat the starting procedure.

NOTE: If the engine fails to start on the first attempt, it will automatically retry a second time without any operator intervention. If the engine fails to start after both attempts, push the battery switch to the OFF position and then refer to the TROUBLESHOOTING instructions.

NOTE: This electric start generator is equipped with a battery charging feature. Once the engine is running, a small charge is supplied to the battery via the battery cables that will slowly recharge the battery.

NOTE: There is no need to alter the starting procedure dependent upon the engine temperature. The generator is equipped with an automatic choke.

4. Connect electrical cords or devices into the 240-Volt AC or 12-Volt DC accessory outlets, or switch them on if already connected, as required.

MANUAL STARTING

NOTE: It is not possible to manually start the generator if the battery is not connected or completely discharged (flat). Ensure that the battery is installed and connected before attempting to manually start the generator. Even though the battery may not have sufficient charge to crank the engine using the electric starter, it can still have enough charge to operate the automatic choke and permit manual starting. If the battery is completely discharged or flat, it will need to be either recharged or replaced with a charged unit before the generator can be started.

1. Turn the fuel control switch anti-clockwise to the ON position (see Figure 11).
2. Push the battery switch to the ON position (see Figure 12).
3. Firmly grasp the recoil starter handle with your hand and pull it slowly until you feel increased resistance. At this point, pull it briskly up and away from the generator (see Figure 14). Do not allow the starter handle to snap back against the engine, but instead return it gently to prevent starter damage. Do not allow the starter cord to rub against other parts of the generator.



Figure 14 – Recoil Starter Handle Operation

4. Repeat Step 3 at approximately three-second intervals until the engine starts running.
5. Connect electrical cords or devices into the 240-Volt AC or 12-Volt DC accessory outlets, or switch them on if already connected, as required.

OPERATION

WIRELESS REMOTE STARTING

NOTE: The supplied remote control fob has already been paired with the generator and is ready for use. If it does not function properly or needs to be replaced or reprogrammed, see Pairing the Remote Control Fob and Generator. The generator can only be paired to work with one remote control fob at any given time.

NOTE: Subject to the remote control's battery condition and environmental factors such as interference, it can start or stop the generator at a range of up to approximately 30 metres.

1. Turn the fuel control switch anti-clockwise to the ON position (see Figure 11).
2. Push the battery switch to the ON position (see Figure 12).
3. Point the remote control fob in the direction of the generator and momentarily press the remote control's ON button for at least one second and then release it (see Figure 15). The electric starter motor will automatically engage and start the engine.



Figure 15 – Wireless Remote Control Fob

NOTE: If the engine fails to start on the first attempt, it will automatically retry a second time without any operator intervention. If the engine fails to start after both attempts, push the battery switch to the OFF position and then refer to the TROUBLESHOOTING instructions.

4. Connect electrical cords or devices into the 240-Volt AC or 12-Volt DC accessory outlets, or switch them on if already connected, as required.

NOTE: When the generator is left in standby mode with its battery switch in the ON position but the engine not running, there is a small power drain on the battery that will cause it to discharge. Depending on the battery's condition and the ambient temperature, it may not have sufficient charge remaining to start the generator upon command from the remote control.

⚠ WARNING



The remote-control fob contains a lithium button/coin cell battery that is hazardous and should always be kept away from children. This applies whether the battery is new or used.

The battery can cause severe or fatal injuries in 2 hours or less if it is swallowed or placed inside any part of the human body.

If it is suspected that the battery has been swallowed or otherwise placed inside any part of the body, contact the Australian Poisons Information Centre by calling 13 11 26 immediately for 24/7 fast, expert advice.

PAIRING THE REMOTE CONTROL FOB AND GENERATOR

If the remote control fob needs to be replaced or reprogrammed, you can pair it to communicate with the generator by following this procedure:

1. Check that the generator is switched off and its engine is not running.
2. Push the battery switch to the ON position.
3. Bring the remote control close to the generator's control panel.
4. Push and hold the engine control button in the ON position for at least 10 seconds and keep it pushed in.
5. Push and hold the ON button on the remote control fob until the generator starts and then release this button and the engine control button.
6. Push the battery switch to the OFF position.

NOTE: The remote control fob is fitted with a single CR2032 non-rechargeable battery that can be replaced by the end user.

ECO THROTTLE CONTROL

The generator is equipped with ECO Throttle Control to minimise fuel consumption and noise. In ECO mode, the generator senses the electrical load demand and adjusts the engine speed and power output to match it; if there is no electrical load connected, the engine speed drops down to idle. ECO mode should only be used once the generator has reached normal operating temperature after running for at least five minutes. When starting large inductive loads such as an air conditioner or pump, ECO mode should be switched off so that the engine speed will be kept higher for maximum electrical starting power availability.

To activate ECO mode, push the ECO throttle switch to the ON position (see Figure 16).

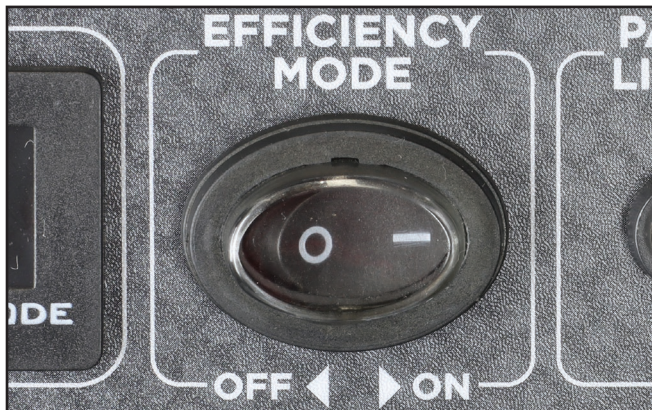

Figure 16 – ECO Throttle Switch in the ON Position

To deactivate ECO mode, push the ECO throttle switch to the OFF position.

OVERLOAD RESET

An electrical overload or short circuit will trip the overload protection system by disconnecting the generator's AC output even though the engine is still running. If this occurs, the overload alarm light will be illuminated red and the output indicator light will be off. The AC output can be restored as follows:

1. Turn off or unplug any electrical devices or cords from the 240-Volt AC or 12-Volt DC accessory receptacles on the control panel.
2. Press the generator reset button on the control panel until the overload alarm light goes off and the output indicator light is illuminated green.
3. Check that the intended electrical running and starting loads do not exceed the generator's capacity or have a licensed electrician rectify any fault causing a short circuit in the load.
4. Reconnect any electrical devices or cords to the receptacles on the control panel and then turn on the electrical loads as required.

STOPPING THE GENERATOR

Normal Operation

During normal operation, use the following steps to stop the generator:

1. Turn off or unplug any electrical cords or devices from the 240-Volt AC or 12-Volt DC accessory receptacles on the control panel, if practicable.
2. Allow the generator to run unloaded for at least one minute to cool and stabilise the engine and alternator temperatures.
3. (a) Momentarily push and release the engine control button. After the generator stops,

push the battery switch to the OFF position and then turn the fuel control switch clockwise to the OFF position; or

- (b) Point the remote control in the direction of the generator and momentarily press the remote control's OFF button for at least one second and then release it.

⚠ WARNING



If stopping the generator by remote control, use audible or visual means to verify that it has stopped running.

Push the battery switch to the OFF position and then turn the fuel control switch to the OFF position unless the generator is required to be in non-operating standby mode awaiting a start command from the remote control fob.

4. Turn the fuel cap vent anti-clockwise to the OFF position.

During an Emergency

If there is an emergency and the generator must be stopped quickly, push the battery switch to the OFF position with haste.

APPLICATION AND DUTY CYCLE

All models within the iGen range of Westinghouse generators are portable, air-cooled, petrol-engine driven, self-contained units designed for independent supply of electrical power. They are ideal as a backup power supply in the event of mains power failure or as a remote area power supply for use when camping, caravanning or working out in the field.

For most common applications, users can connect a Westinghouse generator to power electrical devices by detachable plug and socket-outlet connection as described in this manual.

Westinghouse generators can also be connected to a fixed electrical installation such as in a house or business premises, for example, by a licensed electrician.

AMBIENT CONDITIONS

The generator is designed to operate within the following range of ambient conditions:

- Temperature: -5 to +40°C
- Altitude: Up to 1,000 m

Where possible, the generator should be operated in the shade to prevent additional heat load due to

OPERATION

solar radiation.

The engine's power output will decrease by approximately 3.5% for each 300 m increase in altitude above sea level. This is normal for spark-ignition engines and is attributable to the decrease in atmospheric pressure (and thus the available air for combustion) as altitude increases.

CONNECTING ELECTRICAL LOADS

The generator can be used to power 240-Volt AC, 50 Hz, single phase or 12-Volt DC electrical devices. Maintain normal safety precautions with appliances and accessories as for use when connected to the mains power supply.

240-Volt AC Loads

240-Volt AC devices can be connected either directly or via electrical extension cords into the 240-Volt AC outlet(s) on the generator's control panel. Lift up the spring-loaded weather resistant cover on each outlet for access to connect the electrical device or cord.

240-Volt AC devices may be fitted with either a three-pin 15 Ampere (typically abbreviated "15 Amp" or "15 A") plug or a three-pin 10 Ampere ("10 Amp" or "10 A") plug as shown in Figure 17. Certain double-insulated devices may be fitted with a two-pin 10 A plug that doesn't have an earth pin (which is the longer, vertical pin).

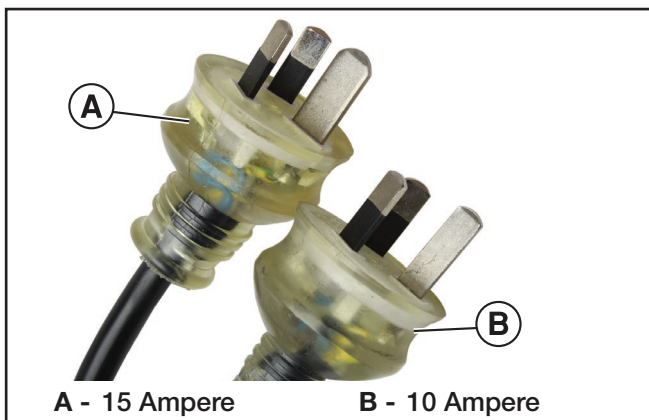

Figure 17 – 240-Volt AC Three-Pin Plugs

NOTICE

Do not connect any 240-Volt AC device that is fitted with a three-pin 20 A plug. This can overload the generator.

See 240-Volt AC Extension Cords for detailed instructions concerning their selection and use.

12-Volt DC Loads

12-Volt DC devices can be connected either directly or via an electrical extension cord not exceeding 3.5 m in length into the 12-Volt DC outlet on the generator's control panel. Pull out the weather resistant stopper on the outlet for access to connect the electrical accessory or cord, and re-insert it after use.

12-Volt DC devices or extension cords must be fitted with a cigarette lighter plug for connection to the generator as shown in Figure 18.



Figure 18 – 12-Volt DC Cigarette Lighter Plug

Power Output and Demand

There are two limits to the amount of electric power that the generator can usefully provide: (a) its total 240-Volt AC or 12-Volt DC electric power generating capacity or power output and (b) the electric current or power output capacity of each individual 240-Volt AC outlet.

The generator's total power output measured in Watts is listed in the Specifications. Two 240-Volt AC power outputs are specified for the generator, namely the running power and the starting power. The 12-Volt DC power output is also specified

NOTICE

Do not overload the generator's 240-Volt AC or 12-Volt DC circuits beyond their rated capacities. This can result in damage to the generator or to the connected devices.

The generator should not be run completely unloaded for extended periods otherwise the engine may be damaged. It is recommended that the generator should always be operated with at least one-third of its rated 240-Volt AC power output.

240-Volt AC devices have two different electric power demands that must be taken into consideration, namely the running power and the starting power. Both are measured in Watts (typically abbreviated as "W").

The steady state continuous load is the running power demand and this is often marked on the device near its model number or serial number. Sometimes the device might only be marked with

its voltage (i.e. 240 Volt or 240 V) and current draw (e.g. 6 Ampere or 6 Amp or 6 A), in which case the running power demand in Watts can be obtained by multiplying the voltage times the current, e.g. $240\text{ V} \times 6\text{ A} = 1,440\text{ W}$.

Simple resistive 240-Volt AC devices such as incandescent bulbs, toasters and heaters have no extra power demand when starting, and so their starting power demands are the same as their running power demands.

More complex 240-Volt AC devices containing inductive or capacitive elements such as electric motors have a momentary extra power demand when starting, which can be up to seven times the running power demand or more. Manufacturers of such devices rarely publish this starting power demand and so it's often necessary to estimate it.

A rule of thumb for devices fitted with an electric motor is to apply a starting power multiplier of 1.2 for small hand-held or portable devices and a value of 3.5 for larger stationary devices. For example, a 900 W angle grinder can be assumed to have a starting power demand of at least $1.2 \times 900\text{ W}$, which equals 1,080 W. Similarly, a 1,650 W air compressor can be assumed to have a starting power demand of at least $3.5 \times 1,650\text{ W}$, which equals 5,775 W.

To prevent overloading of the generator's 240-Volt AC system:

1. Add up the running power demand of all the 240-Volt AC devices that will be connected to the generator at one time. This total must not be greater than the generator's specified running power output.
2. Add up the running power demand again, but for the largest motor-driven device use the value of its starting power demand instead of its running power demand. This total must not be greater than the generator's specified starting power output.
3. The total running power demand of all the devices that will be connected to any one of the generator's outlets must not exceed the generator's specified running power output or 3,600 W, whichever is the lesser.

The above guidelines serve as approximations only of determining the running and starting power demands of 240-Volt AC devices. If in doubt, always err on the conservative side to avoid overloading the generator. In the absence of any power demand information whatsoever, one can assume that any device fitted with a standard domestic 10 A plug has a maximum running power demand of up to 2,400 W (i.e. $240\text{ V} \times 10\text{ A} = 2,400\text{ W}$). Similarly, a device fitted with a heavy duty 15 A plug can be assumed

to have a maximum running power demand of up to 3,600 W (i.e. $240\text{ V} \times 15\text{ A} = 3,600\text{ W}$). And then apply the appropriate multiplying factor for starting power demand if the device has an electric motor.

There are large variations in the performance of different makes and models of electrical devices and the manufacturer's specifications are often inaccurate or misleading. It is recommended that the generator and powered device(s) be trialled to ensure that the combination performs satisfactorily.

240-VOLT AC EXTENSION CORDS

Wherever possible, it is recommended to connect 240-Volt AC devices directly to the generator's 240-Volt AC outlet(s). This ensures that the device is supplied with the best quality electricity.

In those instances where it's not practicable or safe to directly plug an electrical device into the generator, the use of an electrical extension cord is necessary.

1. Locate the generator in a convenient place, avoiding long extension cards and possible damage to them by pedestrian or vehicular traffic.
2. Use only the shortest possible extension cord for the task. Voltage drop increases proportionately with the length of an extension cord and may result in damage to the powered device.
3. Use only a single extension cord and not multiple cords joined together. This will minimise voltage drop and prevent any hazard or inconvenience arising from the joint(s) becoming disconnected.
4. Use only extra heavy duty 15 A extension cords made from 3-core cable of at least 1.5 mm^2 conductor size and fitted with 15 A plugs and sockets (see Figure 10). A 15 A plug cannot be inserted into a standard domestic 10 A socket.
5. Extension cords with conductor size of 1.5 mm^2 or 2.5 mm^2 should not exceed 25 m or 40m in length, respectively, for general use in accordance with AS/NZS 3199:2020.

NOTICE

Do not use extension cords with only 2-pin (active and neutral) plugs and sockets. These extension cords lack the earth connection that is provided by a 3-pin plug and socket joined with a 3-core cable; the vertical pin is the earth connection.

OPERATION

6. Do not use extension cords with any visible signs of damage to the plug, socket or cable.
7. Do not use extension cords that are rolled up or knotted as they may overheat.
8. Check the continuity of the extension cord's earthing core periodically from pin to socket for assured electrical safety.

12 VOLT BATTERY CHARGING

There are two methods by which the generator can be used to charge an external 12 Volt battery:

1. By direct connection to the generator's 12-Volt DC electrical outlet; or
2. By using a mains-powered 12 Volt battery charger connected to one of the generator's 240-Volt AC outlets.

Never use either of these methods to charge the generator's own 12 Volt battery, if equipped.

 **DANGER**



Wet cell batteries produce explosive hydrogen gas while charging. If ignited, the hydrogen gas mixture can explode the battery and cause serious injury or blindness. Only charge a battery in a well-ventilated area away from any sources of ignition such as sparks, open flames, matches, cigarettes, CB radios and mobile phones.



The electrolyte fluid inside a battery contains highly corrosive sulphuric acid, which upon contact with the skin or eyes can cause severe burns or blindness. Always wear protective glasses and clothing – including gloves – when working on a battery. Any electrolyte spill should be thoroughly flushed clean with water.

Battery Charging by Direct Connection

This method is not recommended and should only be used in an emergency. The generator's 12-Volt DC electrical output is unregulated and may damage the battery due to overcharging.

Tools required: 12 V DC, 10 A minimum battery charging cable with cigarette lighter plug for connection to the generator and alligator clips (both positive and negative) for connection to the battery.

1. Prepare the battery for charging if it is a user-maintainable type by removing the vent caps and adding demineralised or distilled water until the electrolyte level is just above the internal

battery plates. This may not be possible with a maintenance-free battery.

2. Connect the positive (+) alligator clip (red) to the positive (+) terminal on the battery.
3. Connect the negative (-) alligator clip (black) to the negative (-) terminal on the battery.
4. Start the generator.
5. Insert the cigarette lighter plug into the generator's 12-Volt DC accessory socket. The battery is now charging. Keep the battery as far away as possible from the generator due to the explosive gas hazard.
6. Monitor the battery; stop charging if the battery gets hot to the touch and the electrolyte boils violently.
7. Variables such as battery size and initial state of charge make it impossible to definitively recommend the charging period. Some batteries have a state of charge indicator that can be visually checked. Otherwise a voltmeter or hydrometer is necessary to accurately determine the battery's condition. A fully charged battery will have an open circuit voltage of at least 12.6 V and an electrolyte specific gravity of at least 1.265. In the absence of any state of charge tools, stop the charging after approximately three hours and check whether the battery is capable of powering the required application, e.g. to start a car's engine.
8. Remove the cigarette lighter plug from the generator's 12-Volt DC accessory socket.
9. Stop the generator unless it's being used to power some other 240-Volt AC device(s).
10. Disconnect the negative (-) alligator clip (black) from the negative (-) terminal on the battery.
11. Disconnect the positive (+) alligator clip (red) from the positive (+) terminal on the battery.
12. Refit the battery's vent caps, if applicable. The battery can now be used.

Battery Charging by a Mains-Powered Charger

This method is recommended. Using a proprietary mains-powered 12 Volt battery charger will ensure that the battery is optimally charged and without risk of damage due to overcharging.

Tools required – 240-Volt AC powered 12 V DC battery charger.

1. Prepare the battery for charging if it is a user-maintainable type by removing the vent caps and adding demineralised or distilled water until the electrolyte level is just above the internal battery plates. This may not be possible with a maintenance-free battery.

2. Connect the battery charger's positive (+) alligator clip or terminal clamp (red) to the positive (+) terminal on the battery.
3. Connect the battery charger's negative (-) alligator clip or terminal clamp (black) to the negative (-) terminal on the battery.
4. Start the generator.
5. Make any necessary pre-charging adjustments or settings on the battery charger in accordance with its operating instructions.
6. Insert the battery charger's power supply plug into one of the generator's 240-Volt AC outlet sockets and then switch the battery charger ON. The battery is now charging. Keep the battery as far away as possible from the generator due to the explosive gas hazard.
7. Monitor the battery; stop charging if the battery gets hot to the touch and the electrolyte boils violently.
8. Monitor the battery charger in accordance with its operating instructions and switch it off when indicated to do so.
9. Switch the battery charger OFF and unplug its power supply cord from the generator.
10. Stop the generator unless it's being used to power some other 240-Volt AC device(s).
11. Disconnect the battery charger's negative (-) alligator clip or terminal clamp (black) from the negative (-) terminal on the battery.
12. Disconnect the battery charger's positive (+) alligator clip or terminal clamp (red) from the positive (+) terminal on the battery.
13. Refit the battery's vent caps, if applicable. The battery is now charged and ready for use.

TRANSPORTING THE GENERATOR

The generator should be stopped and both the fuel control switch and fuel cap vent should be turned to the OFF position before transporting the generator. Keep the unit level during transport to minimise the possibility of fuel leakage or, if practicable, drain out the fuel prior to transport as described in Draining the Fuel.

If the generator has been operating, allow the unit to cool down before loading it onto the transport vehicle.

The wheels are only intended for ease of moving the generator around by hand. The wheels are not suitable for towing the generator either on or off-road.

Use only the generator's fixed handle for lifting the unit or attaching any load restraints such as ropes or tie-down straps. Do not attempt to lift or secure the generator by holding onto any of its other components.

The generator is also equipped with an extendable handle. To deploy it, push on the locking button and pull on the handle until it's fully extended (see Figure 19). To stow it, push on the locking button and push on the handle until it's fully retracted. Only extend or retract the handle while the generator is stationary and resting on a horizontal surface.

The extendable handle is intended for ease of wheeling the generator around by hand (see Figure 20). Do not use the extendable handle to lift the generator entirely off the ground, tow it or up-end it.



Figure 19 - Extendable Handle



Figure 20 - Generator Handling

MAINTENANCE

MAINTENANCE PRECAUTIONS

⚠ WARNING

 Avoid accidentally starting the generator during maintenance by removing the spark plug boot from the spark plug and disconnecting the onboard battery.

 Allow hot components to cool to the touch prior to performing any maintenance procedure.

 Internal pressure can build in the engine crankcase while the engine is running. Removing the oil fill plug while the engine is hot can cause hot oil to spray out of the crankcase and cause severe skin burns. Allow engine oil to cool for several minutes before removing the oil fill plug.

 Always perform maintenance in a well-ventilated area. Fuel and fuel vapours are extremely flammable and can ignite under certain conditions.

⚠ CAUTION

 Avoid skin contact with engine oil or fuel. Prolonged skin contact with engine oil or fuel can be harmful. Frequent and prolonged contact with engine oil may cause skin cancer. Take protective measures and wear protective clothing and equipment. Wash all exposed skin with soap and water.

MAINTENANCE SCHEDULE

⚠ WARNING

 Failure to perform periodic maintenance or not following maintenance procedures can cause the generator to malfunction and could result in death or serious injury.

NOTICE

Periodic maintenance intervals vary depending on generator operating conditions. Operating the generator under severe conditions, such as sustained high-load, high-temperature, or unusually wet or dusty environments, will require more frequent periodic maintenance. The intervals listed in the maintenance schedule should be treated only as a general minimum guideline. Use only genuine Westinghouse spare parts or others as specified herein. Non-genuine spare parts may be of inferior quality and cause damage to the generator.

Following the maintenance schedule is essential to keep the generator in good operating condition. Table 1 provides a summary of routine inspection procedures and simple maintenance tasks that can be performed by someone with mechanical proficiency using commonly available hand tools. Alternatively, an authorised Westinghouse service dealer can carry out this work for a fee.

Table 1: Basic Maintenance Schedule - Owner Performed

Maintenance Item	Before Every Use	After First 20 Hours or First Month *	After 50 Hours or Every 3 Months *	After 100 Hours or Every 6 Months *	After 250 Hours or Every Year *
Engine Oil	Check / Add	Change	–	Change	–
Air Filter	–	–	Clean ^	–	–
Battery	–	–	Recharge #	–	–
Spark Plug	–	–	–	Check / Clean	Replace
Fuel Strainer	–	–	–	Clean	–
Spark Arrestor	–	–	–	Clean	–
Exterior Surfaces	Check / Clean	–	–	–	–

* Whichever occurs first. ^ Service more frequently in dusty conditions. # Recharge after every 3 months of non-use.

Table 2 lists the more complicated maintenance tasks that are best performed by a qualified mechanic using specialised tools. It is recommended to engage an authorised Westinghouse service dealer to carry out this work.

Table 2: Advanced Maintenance Schedule - Authorised Westinghouse Service Dealer Performed

Maintenance Item	After 250 Hours or Every Year *	After 500 Hours or Every 2 Years *
Fuel Filter	Replace	-
Valve Clearance	Check / Adjust	-

* Whichever occurs first.

ENGINE OIL

Engine Oil Specification

Use premium quality 4-stroke engine oil with an API Service Classification of at least SF. An SAE multigrade viscosity of 10W-30 is suitable for use in ambient temperatures of up to 40°C.

NEVER use 2-stroke engine oil either directly in the engine or mixed with the fuel.

Mineral based, semi-synthetic or fully synthetic oils may be used, but different types of oils should not be mixed together. The engine oil supplied originally with the generator is a mineral type with SAE 10W-30 viscosity.

Checking Engine Oil

NOTICE

Always maintain proper engine oil level. Failure to maintain proper engine oil level can damage the engine. Always use the specified engine oil. Failure to use the specified engine oil can damage the engine.

Tools required - None.

Engine oil level should be checked before every use.

1. Always operate or maintain the generator on a flat surface.
2. Stop engine if running.
3. Let engine sit and cool for several minutes (allow crankcase pressure to equalise).
4. Turn the RHS maintenance access cover lock anti-clockwise to the unlocked position (see Figure 42).
5. Grip and pull away on the RHS maintenance tab to open and remove the cover (see Figure 43).
6. Remove the oil fill plug by unscrewing it anti-clockwise (see Figure 21).

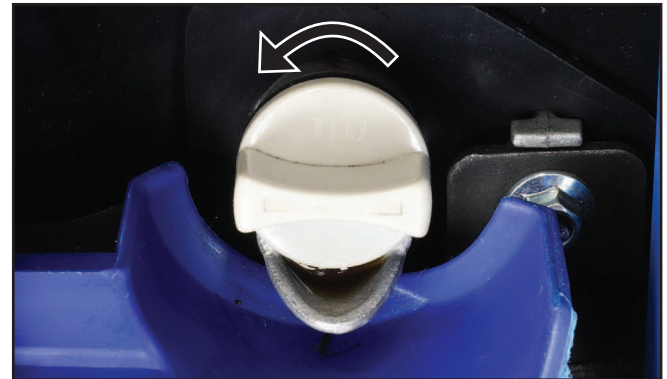

Figure 21 - Removing the Oil Fill Plug

7. Check oil level:
 - Acceptable Oil Level – Oil surface is at the bottom lip of the oil fill plug opening (see Figure 22).
 - Low Oil Level – Oil surface is below the bottom lip of the oil fill plug opening. Add oil as required. See Adding Engine Oil.
 - Too High Oil Level - Oil flows out when the oil fill plug is removed. Allow the excess oil to drain out into a waste oil container.
8. Reinstall the oil fill plug and maintenance access cover.



Figure 22 - Checking Oil Level

Adding Engine Oil

Tools required - None.

1. Always operate or maintain the generator on a flat surface.
2. Stop the engine, if running.
3. Let engine cool down for several minutes allowing crankcase pressure to equalise.

MAINTENANCE

4. Remove the RHS maintenance access cover (see Figures 42 and 43).
5. Thoroughly clean around the oil fill plug.
6. Remove the oil fill plug.
7. Select proper engine oil as described in Engine Oil Specification.
8. Screw the supplied oil funnel into the threaded oil fill plug hole and slowly add engine oil to the engine as shown in Figure 23. Check the oil level periodically to avoid overfilling.



Figure 23 – Adding Engine Oil

9. Continue to add oil until the oil is at the correct level. See Checking Engine Oil. A simple visual guide is to observe the oil level relative to the bottom lip of the oil filler neck in the engine into which the oil fill plug is screwed. If the oil reaches the bottom lip, then it's at the high level. If the oil is above the bottom lip and flows out of the hole, then it's too full and the excess must be drained out.
10. Unscrew the oil funnel and then reinstall the oil fill plug and maintenance access cover.

Changing Engine Oil

Tools required - None.

1. Stop the engine, if running.
2. Let engine cool down for several minutes allowing crankcase pressure to equalise.
3. Remove the RHS maintenance access cover (see Figures 42 and 43).
4. Place oil drain pan or other suitable container adjacent to the right-hand side of the generator.
5. Remove the oil drain hose from its stowed position (see Figure 24).
6. Thoroughly clean around the oil fill plug with a rag.
7. Remove the oil fill plug. Once removed, place the oil fill plug on a clean surface.
8. Remove the end cap from the oil drain hose by unscrewing it a quarter of a turn anti-clockwise.



Figure 24 – Oil Drain Hose

9. Position the hose to drain the oil into the waste oil pan or container (see Figure 25). Tilt the generator over if necessary to aid the discharge.
10. Allow oil to drain completely.

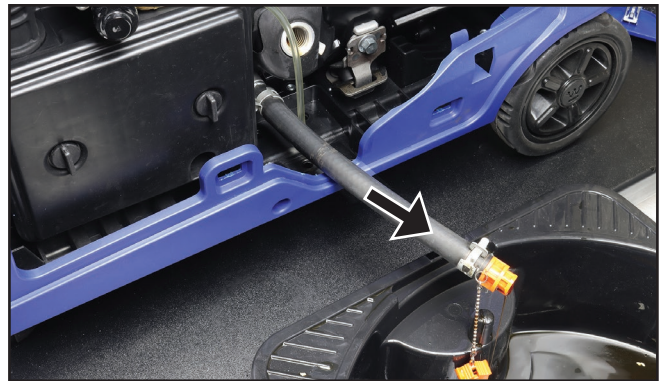

Figure 25 – Draining the Engine Oil

11. Replace the end cap on the oil drain hose by screwing it on a quarter of a turn clockwise and then stow the hose securely in its normal position inside the generator casing.
12. Fill crankcase with new oil following the steps outlined in Adding Engine Oil.
13. Reinstall the oil fill plug and maintenance access cover.

NOTICE

Never dispose of used engine oil by dumping the oil into a sewer, on the ground, or into groundwater or waterways. Always be environmentally responsible. Follow the guidelines of the government agencies for proper disposal of hazardous materials. Consult local authorities or reclamation facility.

AIR FILTER

⚠ WARNING



Never use fuel or other flammable solvents to clean the air filter. Use only household detergent and warm water or alternatively a non-flammable solvent.

NOTICE

Do not operate the generator without an air filter element or with a damaged air filter element. This will allow dirt to enter the engine and cause accelerated wear.

Cleaning the Air Filter

Tools required - None.

The air filter must be cleaned after every 50 hours of use or 3 months (frequency should be increased if generator is operated in a dusty environment).

1. Turn off the generator and let it cool for several minutes if it's been running.
2. Move the generator to a flat, level surface.
3. Remove the RHS maintenance access cover (see Figures 42 and 43).
4. Remove the air filter cover by undoing the two fixing screws to release the cover (see Figure 26). Clean the air filter cover with a rag and place it aside.

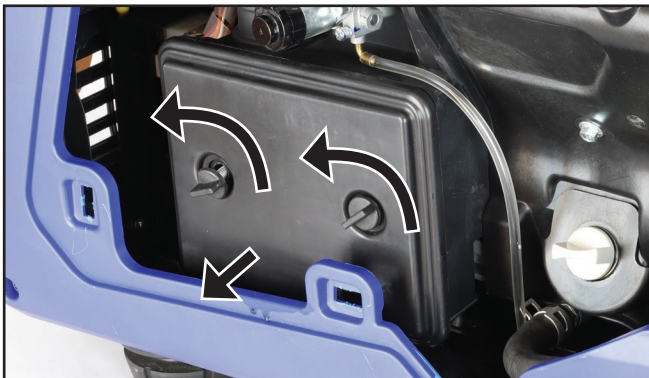

Figure 26 - Removing the Air Filter Cover

5. Remove the foam air filter element while taking care to note its shape and orientation (see Figure 27). The air filter element must be re-installed later in the same position.
6. Wash the air filter element in a solution of household detergent and warm water or alternatively in non-flammable solvent. Slowly squeeze the foam in the liquid for a thorough cleaning action. Then remove the foam and squeeze out the liquid.



Figure 27 - Removing the Air Filter Element

NOTICE

Do not twist or tear the air filter element during cleaning or drying. Apply only a slow and firm squeezing action.

7. Rinse the air filter element by immersing it in fresh water and applying a slow squeezing action.

NOTICE

Never dispose of the used cleaning solution or solvent by dumping it into a sewer, on the ground, into groundwater or into a waterway. Always be environmentally responsible. Follow the guidelines of the governmental agencies for proper disposal of hazardous materials. Consult local authorities or reclamation facility.

8. Dry the air filter element by repeatedly applying a slow firm squeezing action.
9. Coat the air filter element in clean engine oil and then thoroughly squeeze out the excess liquid.
10. Reinstall the air filter element inside the air filter housing while taking care to ensure that the element is correctly positioned.
11. Reinstall the air filter cover and maintenance access cover.

NOTE: Replace the air filter element if it cannot be adequately cleaned.

12 VOLT BATTERY

The generator's 12 Volt battery is a sealed lead acid type that requires no regular maintenance other than charging. It is automatically charged whenever the generator is running.

The battery will self-discharge slowly when not in use and after some time it may not have sufficient charge to start the generator. In such an event, it may be possible to start the generator manually or otherwise it will be necessary to recharge or replace the battery. When left in standby mode, the battery will discharge slightly faster due to the small power

MAINTENANCE

consumption of the battery switch indicator light and remote control signal receiver.

To maximise the battery's working life, the generator should be run at least once per month for 30 minutes to recharge it. If this is not possible, the battery should be fully recharged after no more than 3 months of non-use.

Charging the Battery

When the generator is not in use, its 12 Volt battery can be charged using the mains-powered battery charger originally supplied with the generator.

Tools required - None.

1. Ensure the generator is stopped and the battery switch is in the OFF position.
2. Remove the LHS maintenance access cover (see Figures 5 and 6).
3. Check that the battery is securely installed and properly connected to the generator (see Figures 7 and 8).
4. Inspect the battery for any signs of swelling, bulging, leaking, overheating or mechanical damage. If any of these conditions is observed, replace the battery with a new one before proceeding further.
5. Insert the barrel plug end of the battery charger output cable into the battery charging inlet socket on the generator's control panel (see Figures 4 and 28).

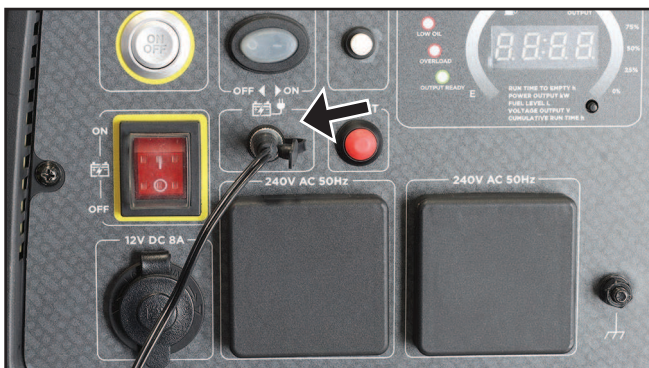

Figure 28 – Connecting the Battery Charger to the Generator

6. Insert the plug pins on the battery charger into a 240-Volt AC mains power outlet socket and then switch it on. The indicator light will illuminate red when battery charging is in progress or green when battery charging is complete (see Figure 29).



Figure 29 – Connecting the Battery Charger to Mains Power Supply

- NOTE:** The indicator light will also illuminate green if the battery charger is energised from a 240-Volt AC power supply and its output is not properly connected to the battery. Check and ensure that the battery charger is properly connected to the generator before switching it on.
7. Monitor the battery during charging for any signs of heat, noise, smell, smoke or physical distortion. If any of these conditions is observed, immediately switch off the battery charger and then replace the battery with a new one before proceeding further.
 8. When the indicator light turns green, you can switch off the mains power supply to the battery charger and disconnect it from the generator if desired.
 9. Reinstall the LHS maintenance access cover.

NOTE: You can switch off and disconnect the battery charger before using the generator, if desired.

NOTE: Do not plug the supplied battery charger into the generator's 240-Volt AC outlet to charge its onboard battery.

Replacing the Battery

It is recommended to use a genuine replacement battery purchased from an authorised Westinghouse Outdoor Power Equipment dealer or service agent for optimum fit and performance.

Tools required - 8 mm open-ended or ring spanner.

1. Stop the generator, if running, and push the battery switch to the OFF position.
2. Remove the LHS maintenance access cover.
3. Let engine cool down until it is at ambient temperature.

4. Disconnect the two halves of the battery wiring harness connector by pulling them apart from one another.
5. Undo the bolt affixing the battery clamp (see Figure 7) and then carefully pull the battery out of the generator. Refit the protective rubber plug onto the end of the battery's wiring harness connector.
6. Install the new battery into the battery holder and refit the battery clamp (see Figure 7). Check that the battery cables are not kinked or pinched.
7. Remove the protective rubber plug from the end of the battery wiring harness connector and stow it away from any hot-running engine components or where it might interfere with the access cover.
8. Assemble the connector by firmly pushing the two halves together (see Figure 8).
9. Charge the battery in accordance with the procedure described in the preceding section.
10. Reinstall the LHS maintenance access cover.

NOTICE

Do not pollute the environment by improper or illegal disposal of the generator battery. Dispose of the hazardous Lithium Ion battery pack intact at an authorised waste collection or recycling facility.

FUEL STRAINER

Cleaning the Fuel Strainer

Tools required - None.

Check and clean the fuel strainer after every 100 hours of use or 6 months. It is recommended that this maintenance task also be performed each time when filling with fuel from any source other than directly from a service station bowser.

1. Stop the generator, if running.
2. Allow the generator to cool down until the muffler access cover is cool to the touch.
3. Remove the generator to a flat surface.
4. Clean area around the fuel cap.
5. Turn the fuel cap vent to the ON position, if equipped.
6. Remove the fuel cap and set it aside on a clean surface.
7. Remove the fuel strainer by hand from inside the filler hole on top of the fuel tank (see Figure 30) while taking care not to tear or otherwise damage the fine mesh screen. Keep the fuel strainer

vertical so that any trapped liquid or solids do not spill onto the generator.

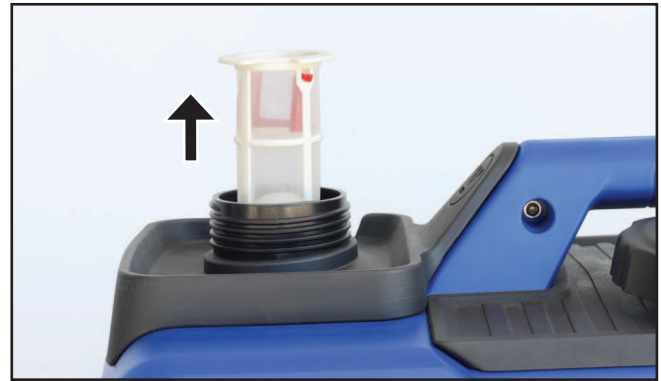

Figure 30 – Removing the Fuel Strainer

8. Pour the contents of the fuel strainer into a suitable waste receptacle. Low pressure compressed air can be used if necessary for blowing onto the outside of the strainer mesh to remove any trapped fine grit.

NOTICE

Never dispose of fuel or fuel contaminants by dumping either of them into a sewer, on the ground, or into groundwater or waterways. Always be environmentally responsible. Follow the guidelines of the government agencies for proper disposal of hazardous materials. Consult local authorities or reclamation facility.

9. Reinstall the fuel strainer by hand inside the filler hole on top of the fuel tank (see Figure 31). Make sure it is fully inserted into the opening.
10. Reinstall the fuel cap.

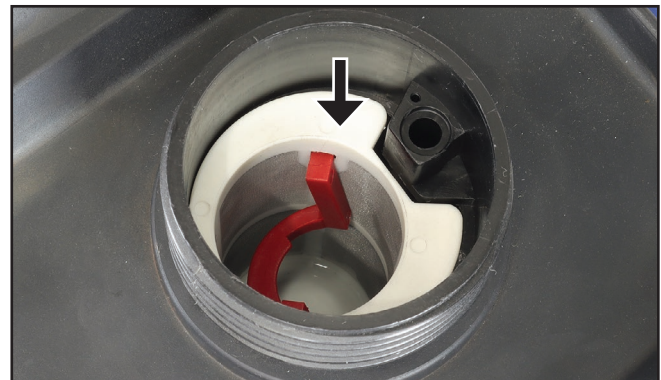

Figure 31 – Reinstalling the Fuel Strainer

SPARK PLUG

Cleaning and Replacing the Spark Plug

Tools required – Spark plug socket wrench (supplied), spark plug gap tool or feeler gauge, and wire brush.

MAINTENANCE

The spark plug should be checked and cleaned after every 100 hours of use or 6 months and then replaced after 250 hours of use or every year.

1. Stop the generator and let it cool for several minutes if it's been running.
2. Move the generator to a flat, level surface.
3. Unlock and remove the RHS maintenance access cover (see Figures 42 and 43).
4. Remove the spark plug access cover by lifting up its locking tab (see Figure 32).
5. Remove the spark plug boot by firmly pulling it up and away from the engine (see Figure 33).



Figure 32 – Removing the Spark Plug Access Cover



Figure 33– Removing the Spark Plug Boot

6. Clean area around the spark plug.

NOTICE

Never apply any side load or move the spark plug laterally when removing the spark plug. Applying a side load or moving the spark plug laterally may crack or damage the spark plug insulator.

7. Use a spark plug socket wrench to remove the spark plug from the cylinder head by unscrewing it anti-clockwise (see Figure 34).
8. Place a clean rag over the opening created by the removal of the spark plug to make sure no dirt can get into the combustion chamber.

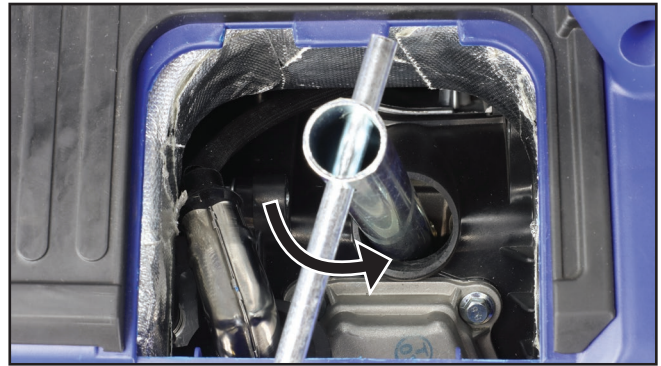

Figure 34 – Removing the Spark Plug

9. Inspect the spark plug for:
 - Cracked or chipped insulator; replace the spark plug.
 - Excessive wear of the electrodes; replace the spark plug.
 - Excessive carbon or oil fouling of the electrodes; clean the electrodes with a wire brush or replace the spark plug.
 - Spark plug gap of 0.7 mm or 0.028 inch (see Figure 35); after cleaning with a wire brush, check using a spark plug gap tool or feeler gauge and adjust by carefully bending the ground electrode. Always check the gap of a new spark plug before installing it.

When replacing the spark plug, use only the specified part as listed in Table 3.

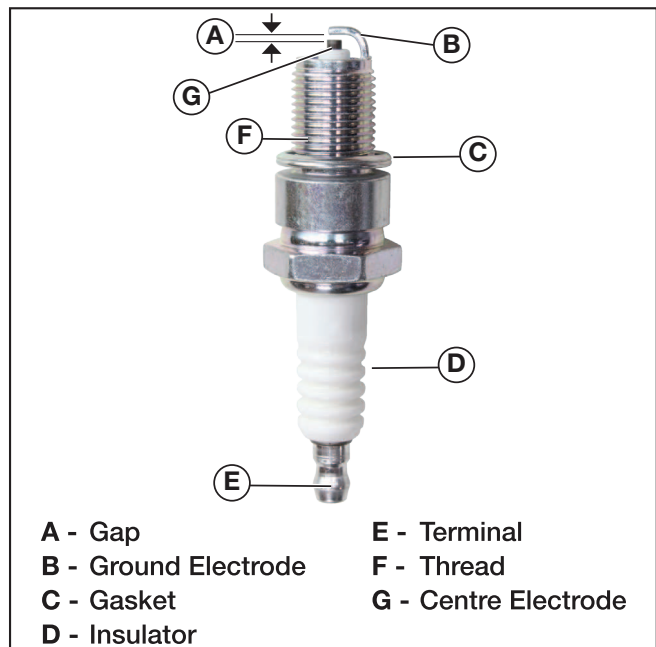

Figure 35 – Spark Plug

Table 3: Replacement Spark Plug for iGen4750s

Spark Plug Make and Model			
Torch	Bosch	Denso	NGK
F7RTC	-	W22EPR-U	BPR7ES

NOTICE

Use only the recommended spark plug (Torch brand) or equivalent. The use of a non-recommended spark plug can damage the engine.

10. Install the spark plug by following the steps outlined below:
 - a - Carefully insert the spark plug back into the cylinder head. Hand screw the spark plug clockwise until it bottoms out (seats).
 - b - Use a spark plug socket wrench to finish tightening the spark plug. If reinstalling a used spark plug, tighten approximately 1/8 to 1/4 of a turn after the spark plug seats. If installing a new spark plug, tighten approximately 1/4 to 1/2 of a turn after the spark plug seats. The tightening torque should not exceed 17 Nm (13 lb-ft).
 - c - Reinstall the spark plug boot, making sure the boot fully engages onto the spark plug's terminal.
11. Reinstall the spark plug and maintenance access covers.

SPARK ARRESTOR

Cleaning the Spark Arrestor

Tools required – 8 mm socket wrench.

Check and clean the spark arrestor after every 100 hours of use or 6 months.

1. Stop the generator and let it cool for several minutes if it's been running.
2. Move the generator to a flat, level surface.
3. Remove the spark arrestor clamp by undoing the two bolts affixing it to the muffler (see Figure 36).
4. Pull off the screen and remove the spark arrestor (see Figure 37).
5. Use a wire brush to remove any exhaust deposits that may have collected on the spark arrestor and screen (see Figure 37).
6. If the spark arrestor or screen show signs of wear such as rips, tears or large openings, they should both be replaced.
7. Reinstall the spark arrestor, screen, clamp and bolts.

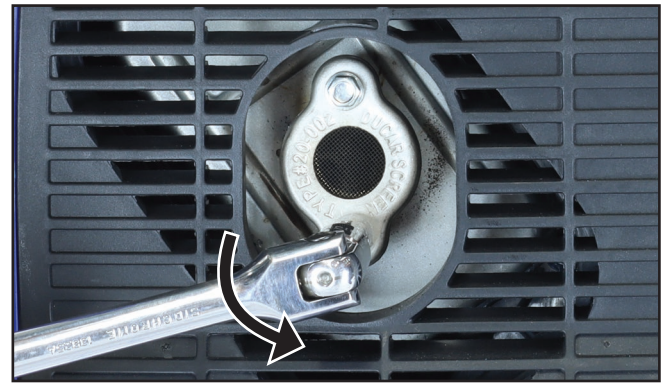

Figure 36 - Removing the Spark Arrestor Clamp

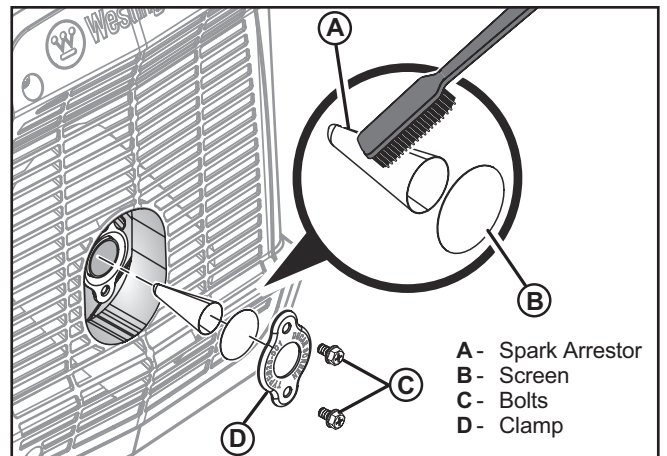

Figure 37 - Removing and Cleaning the Spark Arrestor

REPLACING THE FUEL FILTER

Tools required – Phillips head screwdriver (supplied) and a pair of pliers.

The fuel filter should be replaced after every 250 hours of use or one year. It may need to be changed earlier if the generator is inadvertently filled with contaminated fuel.

1. Stop the generator, if running.
2. Ensure that the battery switch is in the OFF position.
3. Turn both the fuel cap vent and the fuel control switch to the OFF position.
4. Allow the generator to cool down until the muffler access cover is cool to the touch.
5. Move the generator to a flat, level surface preferably at a comfortable working height for maintenance.
6. Partially or fully deploy the extendable handle.
7. Remove the six screws affixing the front maintenance access cover assembly to the generator (see Figure 38) and gently pull the cover forwards away from the casing. Take care

MAINTENANCE

not to disconnect any of the electrical cables that tether the cover to the generator.



Figure 38 – Removing the Front Maintenance Cover Assembly

8. Locate the red-coloured fuel filter and note its orientation (see Figure 39).



Figure 39 – Replacing the Fuel Filter

9. Use pliers to squeeze the fuel hose clip tails together (to loosen their clamping force) while pulling off the fuel hoses. Use a rag to catch and clean up any drops of fuel that may drip out from the hoses or filter.
10. Using a new fuel filter in the correct orientation, reattach the fuel hoses and refit the clips.
11. Turn both the fuel control switch and fuel cap vent to the ON position. Check for fuel leaks from the newly installed fuel filter and reattached fuel hoses. If all is OK, reinstall the front access cover assembly and stow the extendable handle.
12. Turn both the fuel control switch and fuel cap vent to the OFF position.

DANGER



Never operate the generator without its front maintenance access cover assembly properly installed.

CHECKING AND ADJUSTING THE VALVE CLEARANCE

NOTICE

The valve clearance should only be checked or adjusted when the engine has cooled to ambient temperature.

The engine's valve clearance should be checked and adjusted after every 250 hours of use or one year.

Tools required – Spark plug socket wrench (supplied), 8 mm socket wrench, 9 mm open-ended spanner, 100 or 150 mm adjustable wrench, and a set of feeler gauges.

1. Stop the generator, if running.
2. Ensure that the battery switch is in the OFF position.
3. Turn both the fuel control switch and the fuel cap vent to the OFF position.
4. Allow the generator to cool down until the engine is at ambient temperature.
5. Move the generator to a flat, level surface preferably at a comfortable working height for maintenance.
6. Remove the spark plug access cover, spark plug boot and spark plug (see Figures 32, 33 and 34).
7. Remove the RHS maintenance access cover (see Figures 42 and 43).
8. Remove the rocker arm cover (see Figure 40). If the gasket remains wholly intact in situ and there is no visible evidence of it being damaged or leaking, it can be reused. If not, it will need to be replaced during reassembly.

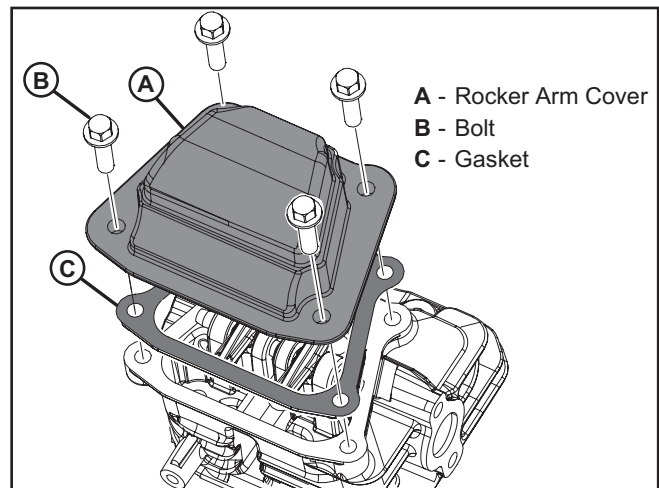

Figure 40 – Removing the Rocker Arm Cover

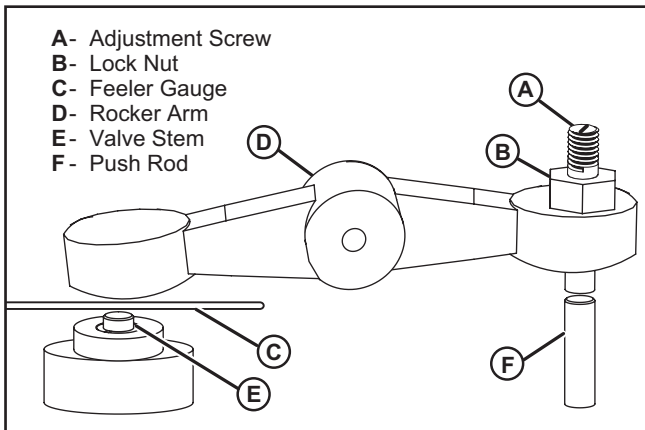

Figure 41 – Adjusting the Valve Clearance

9. Pull the recoil starter handle slowly in small increments until the engine is at top dead center (TDC). Look through the spark plug hole to observe that the piston is at the top of its stroke and check by hand that both rocker arms are loose with some play between each one and its corresponding inlet or exhaust valve (see Figure 41).
10. Insert a feeler gauge between the rocker arm and the valve stem to measure the valve clearance. Refer to Table 4. The inlet valve is that which is closest to the carburettor. If adjustment is required, loosen the lock nut and then turn the adjustment screw as required. After verifying the correct clearance has been set, maintain the position of the adjustment screw by using the adjustable wrench and then tighten the lock nut. If possible, use a torque wrench to precisely tighten the lock nut.

Table 4: Valve Clearance and Lock Nut Torque

Specification	Inlet Valve	Exhaust Valve
Valve Stem to Rocker Arm Clearance	0.08 - 0.12 mm	0.13 - 0.17 mm
Lock Nut Torque	8 - 12 Nm	8 - 12 Nm

11. Double-check the inlet and exhaust valve clearances. If all is OK, reinstall the rocker arm cover, gasket and bolts.
12. Reinstall the spark plug, spark plug boot, spark plug access cover and the RHS maintenance access cover.

MAINTENANCE ACCESS

All routine scheduled maintenance can be performed by removing the left-hand side maintenance access cover (see Figures 5 and 6), the spark plug access cover (see Figure 32) or the front maintenance cover assembly (see Figure 38). Only

the latter requires a tool for its removal, specifically a Phillips head screwdriver (supplied).

The right-hand (RHS) side maintenance access cover and the muffler access cover on the rear of the generator can also be removed easily.

No tools are required to remove the RHS maintenance access cover. Turn the RHS access cover lock anti-clockwise to the unlocked position (see Figure 42). Then grip and pull away on the bottom edge to open and remove the cover (see Figure 43).



Figure 42 – RHS Maintenance Access Cover Lock in the Unlocked Position



Figure 43 – Removing the RHS Maintenance Access Cover



Figure 44 – Removing the Muffler Access Cover

MAINTENANCE

To remove the muffler access cover, use the supplied Phillips head screwdriver to remove the four screws affixing it to the casing. Then grip and pull away on the bottom edge to open and remove the cover (see Figure 44).

CLEANING THE GENERATOR

The generator should be kept clean and dry at all times to ensure its reliable and safe operation. This must be checked each time before using the generator.

Use a damp cloth which has been soaked in a mixture of household detergent and warm water and then wrung out to remove excess liquid. Wipe the exterior surfaces of the generator clean and then repeat with a damp cloth which has been rinsed in clean water and wrung out. Finish by wiping off all moisture with a dry cloth. Do not use abrasive or solvent cleaners.

A soft, non-metallic bristle brush or a vacuum cleaner may be used to loosen and remove any built-up dirt, mud or other debris. Low pressure compressed air may also be used to blow off any dirt or dust.

Make sure all of the ventilation grilles are clean of any dirt or other debris otherwise the generator may overheat and be damaged.

NOTICE

NEVER use a water hose or pressure washer to clean the generator. Water may enter the fuel or electric systems and damage the generator. The risk of electric shock is also possible.

DRAINING THE FUEL

Occasionally it may be necessary to drain all the fuel out of the generator. For example, to remove contaminated or stale fuel or to prepare the generator for transport or storage.

Tools required – Phillips head screwdriver (supplied), fuel siphon hand pump and fuel storage container.

1. Turn both the fuel cap vent and the fuel control switch to the ON position.
2. Remove the fuel cap.
3. Clean the fuel strainer (see Fuel Strainer Maintenance), but do not reinstall it.
4. Pour or siphon the contents of the fuel tank into a fuel storage container (see Figure 45).
5. Remove the RHS maintenance access cover (see Figures 42 and 43).



Figure 45 – Emptying the Fuel Tank

6. Locate the fuel drain hose connected to the bottom of the carburettor float bowl. Take note of the hose's stowed position. Then gently pull the loose end of the hose up and out of the generator casing.
7. Position the fuel storage container to collect the remaining fuel discharged from the drain hose.
8. Use the screwdriver to loosen the fuel drain screw by turning it anti-clockwise and then carefully drain the fuel out (see Figure 46). Take care to wipe up any spills immediately.

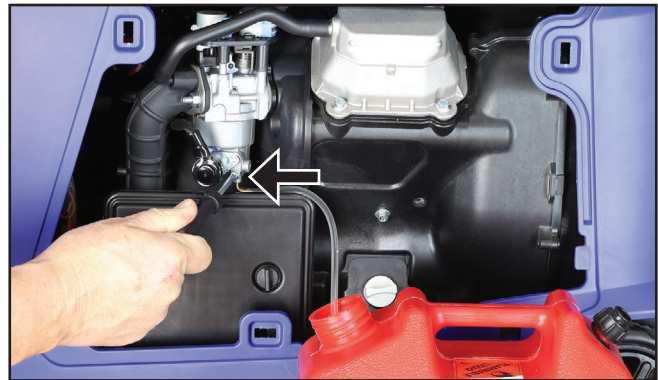

Figure 46 – Draining the Carburettor

9. When all the fuel has been drained out, tighten the fuel drain screw. Move the storage container and any fuel soaked rags away from the generator. It is preferable to consume the fuel in another engine-powered device straight away or dispose of it properly rather than storing it for a long time with fuel stabiliser for later reuse.

NOTICE

Never dispose of fuel or fuel contaminants by dumping either of them into a sewer, on the ground, or into groundwater or waterways. Always be environmentally responsible. Follow the guidelines of the governmental agencies for proper disposal of hazardous materials. Consult local authorities or reclamation facility.

10. Turn the fuel control switch to the OFF position.
 11. Re-stow the fuel drain hose back to its original position routed downwards. Take care to ensure that the hose is correctly routed and not touching any potentially hot components.
 12. Reinstall the maintenance access cover.
 13. Reinstall the fuel strainer.
 14. Reinstall the fuel cap.
 15. Turn the fuel cap vent to the OFF position.
3. Start the generator and run it for 10 minutes to ensure that treated fuel is distributed throughout the engine's fuel system.
 4. Stop the generator (see Stopping the Generator).
 5. Turn the engine control switch to the OFF position if not already done in Step 4.
 6. Turn the fuel cap vent to the OFF position.
 7. Allow the unit to cool down and then move it to a clean, dry place for storage.

LONG-TERM STORAGE

WARNING



Never store a generator with fuel in the tank indoors or in a poorly ventilated area where the fumes can come into contact with an ignition source such as: a pilot light of a stove, water heater, clothes dryer or any other gas appliance; or a spark from an electric appliance.

NOTICE

Fuel stored for as little as 30 days can go bad, causing gum, varnish and corrosive build-up in fuel lines, fuel passages and the engine. This corrosive build-up restricts the flow of fuel, preventing an engine from starting after a prolonged period of storage.

The most commonly experienced faults with portable generators are directly attributable to contaminated or stale fuel. Such faults are not covered by the generator's warranty.

The generator should be run at least once per month for 30 minutes under no less than one-third load. If this is not possible, the generator should be prepared for long-term storage as described hereunder.

Proper care should be taken to prepare the generator for any long-term storage. This will protect the generator's function and appearance, and will make it easier to start when next required.

Storage Procedure for 1 – 3 Months

1. Clean the generator as outlined in Cleaning the Generator.
2. Add a proprietary fuel stabiliser to the fuel tank and then add fresh fuel up to the tank's maximum capacity (see Checking and Adding Fuel). Follow the manufacturer's recommendation for correct amount of stabiliser to add.

Storage Procedure for Greater than 3 Months

1. Clean the generator as outlined in Cleaning the Generator.
2. Drain the fuel (see Draining the Fuel).
3. Start the generator, if possible, and run the engine without load until it stops when the last remnants of fuel have been used. (See Starting the Generator and Stopping the Generator).
4. Change the engine oil (see Changing Engine Oil).
5. Remove the spark plug (see Spark Plug Maintenance) and pour a tablespoon of clean engine oil into the spark plug opening. While placing a clean rag over the spark plug opening, slowly pull the recoil starter handle to rotate the engine several times. This will distribute the oil and protect the cylinder wall from corrosion during storage.
6. Reinstall the spark plug (see Spark Plug Maintenance).
7. Slowly pull the recoil starter handle until resistance is felt, at which point the piston is coming up on its compression stroke and both the intake and exhaust valves are closed. Storing the engine in this position will help to prevent internal corrosion.
8. Move the unit to a clean, dry place for storage.
9. Recharge the battery using the supplied battery charger after every 3 months of non-use (see Charging the Battery).

Removal from Storage

Follow the normal procedures for pre-operation checks and starting (see Before Starting the Generator).

Use only fresh fuel to re-fill the tank, if necessary, rather than re-using any old fuel.

If oil was inserted into the cylinder prior to storage, the exhaust may smoke for a short while after starting the generator; this is normal and will cease within a minute or so of running time.

MAINTENANCE

DISMANTLING AND DISPOSAL

There is no requirement for the generator to be dismantled during normal operation other than for major repair / overhaul or prior to final disposal at the end of its service life.

Dismantling should only be carried out by a mechanically proficient person with access to proper tools or alternatively by your authorised Westinghouse service dealer for a fee.

Before dismantling:

1. Stop the generator (see Stopping the Generator).
2. Drain the engine oil (see Changing Engine Oil).
3. Drain the fuel (see Draining the Fuel).

NOTICE

Do not pollute the environment by improper or illegal disposal of the waste fluids. Dispose of these hazardous items only at an authorised waste collection / recycling facility.

Do not pollute the environment by improper or illegal disposal of the generator either as a whole or in parts. Take the unwanted unit or components to your local recycling centre instead. The generator is made almost entirely of metals that can be recycled.

WARNING



Before attempting to service or troubleshoot the generator, the owner or service technician must first read and understand this instruction manual and comply with all safety instructions. Failure to follow all instructions may result in conditions leading to voiding of the product warranty, serious personal injury, property damage or even death.

PROBLEM	POTENTIAL CAUSE	SOLUTION
Engine will not start or starts and runs rough.	1. Low oil level.	1. Check oil level and add oil if necessary.
	2. Generator is out of fuel.	2. Check fuel level and add fuel if necessary.
	3. Fuel is stale or contaminated with water or other foreign substance.	3. Drain fuel and refill with fresh fuel.
	4. Electrical load connected to generator.	4. Unplug or switch off any electrical cords or devices from the 240-Volt AC receptacles.
	5. Fuel cap vent is in the OFF position.	5. Turn fuel cap vent to the ON position.
	6. Fuel control switch is in the OFF position.	6. Turn fuel control switch to the ON position.
	7. Battery switch is in the OFF position.	7. Push battery switch to the ON position.
	8. Battery is excessively discharged, faulty or not connected.	8. Recharge, replace or reconnect the battery.
	9. Spark plug boot is not properly connected onto spark plug terminal.	9. Push spark plug boot firmly onto spark plug.
	10. Spark plug is dirty or faulty.	10. Clean or replace spark plug.
	11. Air filter is dirty or blocked.	11. Check air filter element and clean if necessary.
	12. Spark arrestor is dirty or blocked.	12. Check spark arrestor and clean if necessary.
	13. If above possible causes are checked and eliminated, generator may be faulty.	13. Take generator to an authorised Westinghouse service dealer.

TROUBLESHOOTING

PROBLEM	POTENTIAL CAUSE	SOLUTION
Electric starter will not crank engine fast enough or at all.	1. Flat battery.	1. Start engine manually, if possible, or recharge battery using the supplied battery charger.
	2. Faulty battery.	2. Replace battery.
	3. Remote control fob is out of range, blocked by interference or not functioning properly.	3. Move the remote control fob closer to and in direct line of sight of the generator. If unresolved, replace the remote control battery and pair the remote control fob with the generator.
	4. Battery switch is in the OFF position.	4. Push battery switch to the ON position.
	5. If above possible causes are checked and eliminated, generator may be faulty.	5. Take generator to an authorised Westinghouse service dealer.
Engine is running, but no 240-Volt AC output is available.	1. If output indicator light is blinking green, generator is still in starting mode and not yet delivering electrical output.	1. Wait 5 seconds for the generator to warm up, stabilise and commence output. No fault.
	2. If output indicator light is continuously green, 240-Volt AC output should be available.	2. Check connected electrical cord(s) or appliance(s) as described below.
	3. Connected electrical cord or appliance plug is not properly inserted into 240-Volt AC outlet socket.	3. Check connected electrical cord or appliance plug is fully inserted into 240-Volt AC outlet socket.
	4. Connected electrical cord or appliance is faulty.	4. Connect known functioning appliance directly into generator's 240-Volt AC outlet socket to verify electrical output.
	5. If output indicator light is not illuminated, there is no 240-Volt AC output available. In such case: <ul style="list-style-type: none"> If overload alarm light is not illuminated, generator may be faulty. If overload alarm light is red, there is an overload or short circuit in the connected 240-Volt AC load. 	5. <ul style="list-style-type: none"> Disconnect all electrical cords and devices from generator and press the generator reset button. If unresolved, stop and restart engine with ECO throttle switch in the OFF position. If still unresolved, take generator to an authorised Westinghouse service dealer. Disconnect all electrical cords and devices from generator and press the generator reset button. If unresolved, stop and restart engine with ECO throttle switch in the OFF position. Reconnect and test run 240-Volt AC loads individually; any single cord or device that trips overload alarm is either faulty or too great a load for the generator. Any faulty device must not be used further until checked and approved by a licensed electrician. Check running and starting power demands of total connected electrical load versus generator's rating.
	6. If above possible causes are checked and eliminated, generator may be faulty.	6. Take generator to an authorised Westinghouse service dealer.

PROBLEM	POTENTIAL CAUSE	SOLUTION
Engine is running, but no 12-Volt DC output is available.	1. If output indicator light is blinking green, generator is still in starting mode and not yet delivering electrical output.	1. Wait 5 seconds for the generator to warm up, stabilise and commence output. No fault.
	2. Connected electrical cord or appliance plug is not properly inserted into the DC outlet socket.	2. Check connected electrical cord or appliance plug is fully inserted into the DC outlet socket.
	3. Connected electrical cord or appliance is faulty.	3. Connect known functioning appliance directly into generator's 12-Volt DC outlet socket to verify electrical output.
	4. Overload or short circuit in the connected DC load	4. Disconnect all electrical cords and devices from the 12-Volt DC outlet socket. Reconnect and test run 12-Volt DC loads individually. Check that the DC device(s) do not overload the generator's rated DC output. Check that the DC device(s) are not faulty, e.g. short circuit. Damage caused to the generator by excessive or faulty DC loads is not covered by warranty. If unresolved, stop and restart engine with ECO throttle switch in the OFF position.
	5. If above possible causes are checked and eliminated, generator may be faulty.	5. Take generator to an authorised Westinghouse service dealer.

TROUBLESHOOTING

PROBLEM	POTENTIAL CAUSE	SOLUTION
Engine stops during operation.	1. Generator is out of fuel.	1. Check fuel level and add fuel if necessary.
	2. Fuel is contaminated with water or other foreign substance.	2. Drain fuel and refill with fresh fuel.
	3. Fuel cap vent is in the OFF position.	3. Turn fuel cap vent to the ON position.
	4. Fuel control switch is in the OFF position.	4. Turn fuel control switch to the ON position.
	5. Low oil level.	5. Check oil level and add oil if necessary.
	6. Spark plug boot is not properly connected onto spark plug terminal.	6. Push spark plug boot firmly onto spark plug.
	7. If above possible causes are checked and eliminated, generator may be faulty.	7. Take generator to an authorised Westinghouse service dealer.

PROBLEM	POTENTIAL CAUSE	SOLUTION
Engine runs erratically or does not hold steady speed.	1. Power demand of connected 240-Volt AC load may be varying.	1. Engine speed varies when electrical load changes; this is normal operation. It is most noticeable when ECO throttle switch is in the ON position. Try pushing the ECO throttle switch to the OFF position. No fault.
	2. If output indicator and overload alarm are both illuminated, there is an overload in the connected 240-Volt AC load.	2. Switch off or unplug connected 240-Volt AC device(s) to reduce electrical power demand.
	3. Engine is not warm enough.	3. Disconnect all electrical cords and appliances from generator. Allow engine to run for at least 2 minutes after the engine control switch has been moved to the ON position before reconnecting electrical loads.
	4. Fuel is stale or contaminated.	4. Drain fuel and refill with fresh fuel.
	5. Air filter is dirty or blocked.	5. Check air filter element and clean if necessary.
	6. If above possible causes are checked and eliminated, generator may be faulty.	6. Take generator to an authorised Westinghouse service dealer.

SPECIFICATIONS

	PARAMETER	iGen4750s
ENGINE	Type	1-Cylinder, 4-Stroke, Overhead Valve, Air Cooled
	Displacement (cm ³)	190
	Max. Speed (rpm)	4,800
	Oil Capacity (mL)	600
	Oil Viscosity	SAE 10W-30
	Low Oil Shutdown	Yes
	Spark Plug	F7RTC
	Spark Plug Gap (mm)	0.60 - 0.80
	Fuel	Unleaded Petrol ‡ (91, 95 or 98 RON)
	Fuel Tank Capacity (L)	12
	Fuel Gauge	Yes
	Starting Method	Electric or Recoil
	Inlet Valve Clearance - Cold (mm)	0.08 - 0.12
	Exhaust Valve Clearance - Cold (mm)	0.13 - 0.17
	240 V AC ELECTRICAL	Voltage (V)
Frequency (Hz)		50
No. of Phases		1
Continuous Running Power (W) *		3,800
Maximum Starting Power (W)		4,750
Continuous Running Current (A)		15.8
Voltage & Waveform Control		Digital Inverter, Pure Sine Wave Output
Receptacle(s)		2 x 15 A, IP44
Overload Protection		Electronic
Alternator		Brushless, Permanent Magnet
Output Power Meter		Yes Δ
12 V DC ELECTRICAL	Voltage (V)	12
	Maximum Current (A)	8
	Maximum Power (W)	100
	Receptacle(s)	8 A, IP44
	Battery	Sealed Lead Acid Type, 12 V, 5 Ah, (10 h Rating)
DIMENSIONS & WEIGHT	Length (mm)	643
	Width (mm)	374
	Height (mm)	574
	Weight - Dry (kg)	36
	Weight - Wet (kg)	46

* Rated output at 1.0 power factor.

Output ready indicator light equipped.

‡ Ethanol blends such as E10 are not recommended.

Δ Displayed on the Data Center.

iGen4750s WIRING DIAGRAM

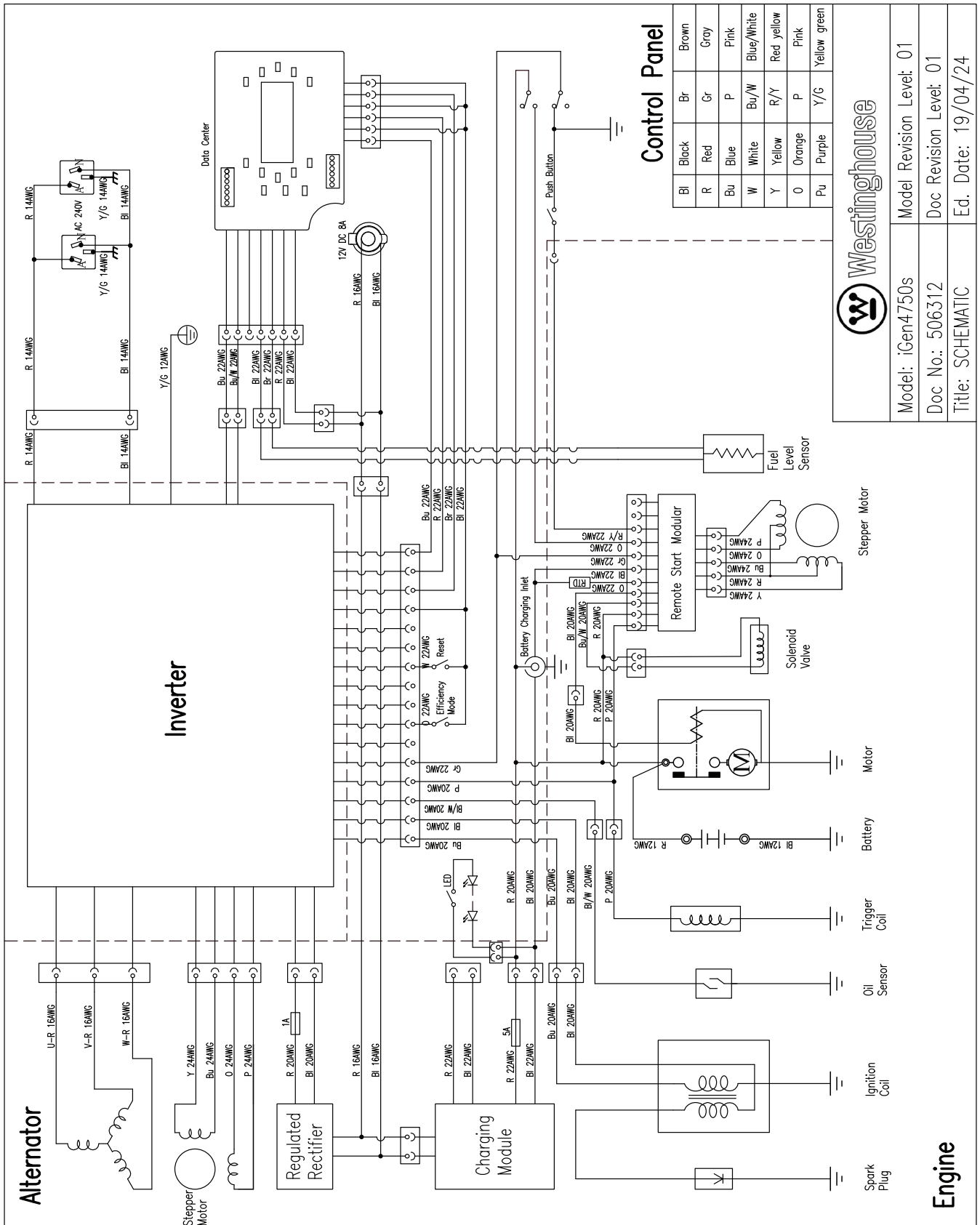

Control Panel

Bi	Black	Br	Brown
R	Red	Gr	Gray
Bu	Blue	P	Pink
W	White	Bu/W	Blue/White
Y	Yellow	R/Y	Red yellow
O	Orange	P	Pink
Pu	Purple	Y/G	Yellow green



Model:	iGen4750s	Model Revision Level:	01
Doc No.:	506312	Doc Revision Level:	01
Title:	SCHEMATIC		
Ed. Date: 19/04/24			

Engine

WARRANTY

WARRANTY AGAINST DEFECTS

Proof of Purchase

It is recommended that you keep a copy of the original tax invoice for your records.

Warrantor

Name: Westinghouse Outdoor Power Equipment (ABN 21101370085)

Address: 19 Corymbia Place
Parkinson, 4115, Australia

Phone: 1800 453 626

Email: info@wpowereq.com.au

Web: westinghouseoutdoorpower.com.au

Warranty Conditions

Westinghouse Outdoor Power Equipment (the “Company”) warrants that its Westinghouse portable electric generators (the “Goods”) shall be free from defects in material and workmanship for a period of two years (2) years or five hundred (500) operating hours, whichever occurs first, from the date of original sale (hereinafter the “Warranty Period”) in normal domestic applications such as personal, residential household or recreational use.

A Warranty Period of one (1) year or five hundred (500) operating hours, whichever occurs first, shall apply in commercial applications such as income producing, rental or other business-related use. Goods sold to a Consumer with an Australian Business Number shall be deemed as being used in a commercial application.

The Warranty Period is continuous from the date of original sale and does not restart upon the repair or replacement of the Goods or any part thereof.

Upon return – transportation charges prepaid by the Consumer – to the Company’s or its nominated dealer’s premises within the Warranty Period, the Company shall repair or replace, at its option, any Goods which it determines to contain defective material or workmanship, and shall return said Goods to the Consumer free-on-board (FOB) at the Company’s or agent’s premises. The repair or replacement work will be scheduled and performed according to the Company’s normal work flow and availability of replacement parts.

The Company shall not be obligated, however, to repair or replace Goods which have been: repaired by others; abused; improperly installed, operated, maintained, repaired, transported or stored; not

serviced to schedule using genuine spare parts; altered or otherwise misused or damaged in any way.

The Company shall not be responsible for any diagnosis, communication, dismantling, packing, handling, freight, and reassembly or reinstallation charges.

Freight damage, pre-delivery service, normal operating adjustments, preventative maintenance service, consumable items, cosmetic damage, corrosion, erosion, normal wear and tear, performance, merchantability, and fitness for a particular purpose are not covered under this Warranty. Consumable items include batteries, filters, fuel, lubricants and spark plugs.

The Company shall not be liable for any repairs, replacements, or adjustments to the Goods or any costs of labour performed by the Consumer or others without the Company’s prior written approval.

To the extent permissible by law and notwithstanding any other clause in these Warranty Conditions, the Company excludes all liability whatsoever to the Consumer arising out of or in any way connected with a contract for any consequential or indirect losses of any kind howsoever arising and whether caused by breach of statute, breach of contract, negligence or other tort.

The Company’s liability will be limited to, in the case of products, the replacement of the products, the supply of equivalent products or the payment of the cost of replacing the products or of acquiring equivalent products or, in the case of services, the supply of the services again or the payment of the cost of having the services supplied again. The choice of remedy will be at the discretion of the Company and the Consumer acknowledges that this limitation of liability is fair and reasonable.

This Warranty is available only to the original Consumer bearing the original tax invoice from the Company or one of its authorised dealers as proof of purchase. Goods purchased from any other party such as a private seller, auction house, eBay seller, etc. are not covered by this Warranty.

Our Goods come with guarantees that cannot be excluded under the Australian Consumer Law. You are entitled to a replacement or refund for a major failure and compensation for any other reasonably foreseeable loss or damage. You are also entitled to have the Goods repaired or replaced if the Goods fail to be of acceptable quality and the failure does not amount to a major failure.



Westinghouse Outdoor Power Equipment
19 Corymbia Place
Parkinson QLD 4115 Australia

© 2024 All rights reserved. Content may change without notice.
Ⓜ and Westinghouse are trademarks of Westinghouse Electric Corporation
used under license by Westinghouse Outdoor Power Equipment.

2024-08-29