

Portable Generator Instruction Manual Supplement

WHXC8500E-AS II

Electrical Connection to the Generator Output Terminals



Westinghouse

INNOVATION YOU CAN BE SURE OF



DANGER



This Instruction Manual Supplement contains important instructions for operating the Westinghouse WHXC8500E-AS II generator.

For your safety and that of others, be sure to read both the main Instruction Manual and this Supplement thoroughly before operating the generator. Failure to properly follow all instructions and precautions can cause you and others to be seriously hurt or killed.

Both the main Instruction Manual and this Supplement should be considered a permanent part of the generator and should remain with it if resold.

WARNING



The output of this generating set is potentially lethal. The set shall not be connected to a fixed electrical installation by fixed wiring except by an appropriately licensed person.

The connection of this generating set to portable tools and appliances or a fixed electrical installation shall comply with the requirements of AS/NZS 3000:2018 Electrical Installations “Wiring Rules” and AS/NZS 3010:2017 *Electrical Installations – Generating Sets*.

The electrical work described in this Supplement shall only be performed by a licensed electrician. It is dangerous and unlawful to do this work without an appropriate electrical work licence.

NOTICE

DO NOT overload the generator’s 240-Volt AC or 12-Volt DC circuits beyond their rated capacities. This can result in damage to the generator or to the connected devices.



CONNECTION

INTRODUCTION

The Westinghouse WHXC8500E-AS II generator as originally supplied is configured for connection to portable tools and appliances or a fixed electrical installation by means of detachable plug and socket outlet connection(s) to either or both of its 240-Volt AC, 15-Amp outlets (see Figure S1).

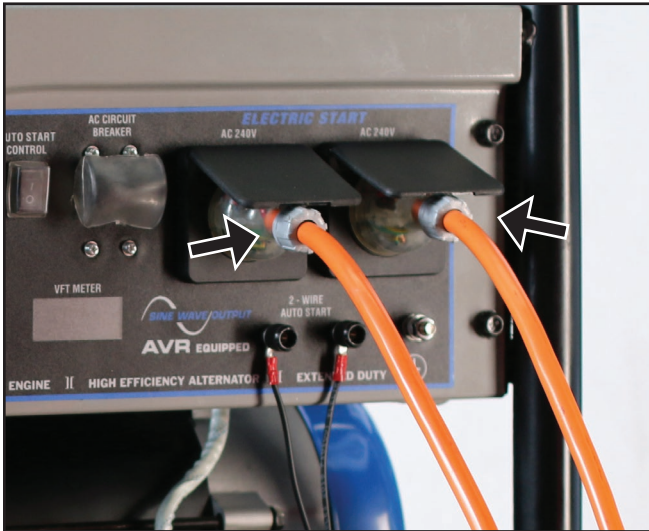

Figure S1 – Connection to the 240-Volt AC, 15-Amp Outlets

The maximum electric current that can be delivered continuously from either of the generator's 240-Volt AC outlets is 15 Amperes (15 A) and thus the maximum continuous electric power output from either outlet is 3,600 Watts (3,600 W).

⚠ WARNING



NEVER connect both of the generator's 240-Volt AC outlets in parallel to the same electrical device, extension cord or fixed electrical installation.

NEVER connect more than one generator to the same electrical device, extension cord or fixed electrical installation.

In some applications, such as connection to an off-grid solar power system for battery charging and backup or connection to a fixed electrical installation as an alternative source of supply, more than 3,600 W of generator output may be required to power a single electrical load. This will necessitate direct connection to the generator's output terminals in accordance with the procedure described hereinafter.

The maximum electric current that can be delivered continuously from this direct connection is 28.1 A, which corresponds to the generator's maximum continuous running power output of 6,750 W.

WORK PROCEDURE

Tools and materials required (not included):

- Phillips Tip Screwdriver #2
- Standard Tip Screwdriver 4 mm Blade
- Standard Tip Screwdriver 5 mm Blade
- Silicone Rubber RTV Adhesive / Sealant (e.g. Silastic™ 732)
- 6 mm² (minimum) 2 Core + Earth Copper, Insulated and Sheathed Circular Cable
- Cable Jointing Tools and Materials
- M25 Cable Gland
- Tools for Cable Gland tightening (if required)

1. Check the cable gland plate kit supplied with the generator and verify its components against those shown in Figure S2.

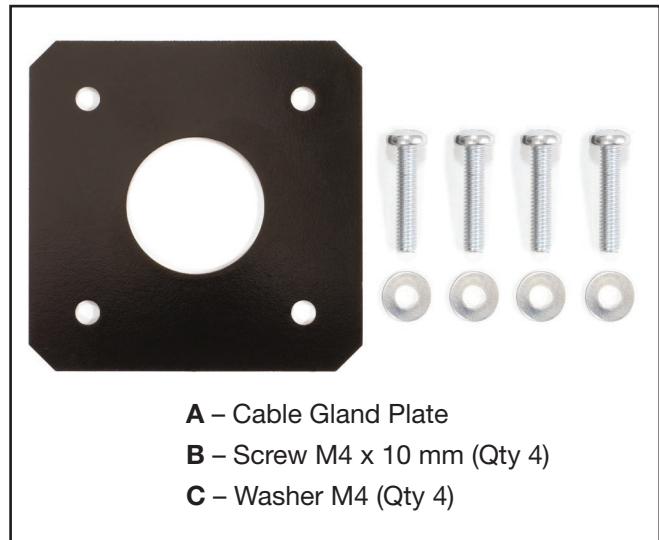

Figure S2 – Cable Gland Plate Kit Components

2. Turn the generator's engine control switch to the STOP position. Unplug any electrical cords or appliances from its 240-Volt AC and 12-Volt DC sockets. Remove the spark plug boot from the spark plug. Disconnect the battery cables from the battery starting with the negative (-) cable first and move the wires away from the terminals to avoid arcing.

- Remove the snap-on cover from the right-hand-side 240-Volt AC socket only using a small flat blade screwdriver (see Figure S3).

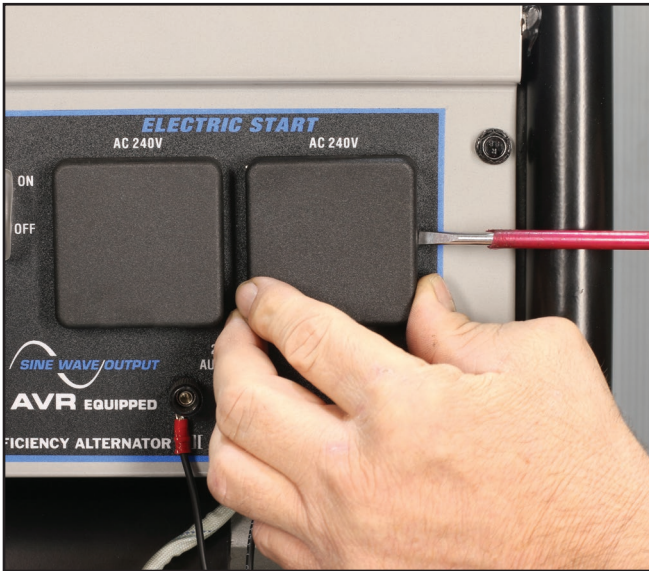

Figure S3 – Removing the 240-Volt AC Socket Cover

- Unscrew the socket from the control panel using a #2 Phillips screwdriver (see Figure S4). It is recommended to retain the screws for future re-installation of the socket.

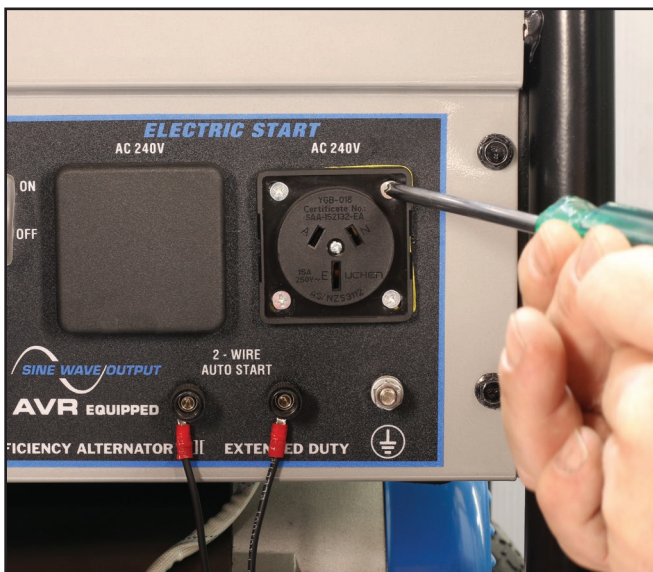

Figure S4 – Removing the 240-Volt AC Socket

- Withdraw the socket from the control panel to give access to the wiring terminal screws on the back of the socket (see Figure S5).



Figure S5 – Withdrawing the 240-Volt AC Socket

- Disconnect the active, neutral and earth wires from the socket by unscrewing the wire terminals with a flat blade screwdriver (see Figure S6). It is recommended to retain both the socket and its mounting gasket for future re-installation.



Figure S6 – Disconnecting the 240-Volt AC Socket

- Pre-assemble one end of the new direct-connection cable by feeding it through the cable gland and then insert the cable gland into the gland plate and loosely screw on its locking nut (see Figure S7).

CONNECTION

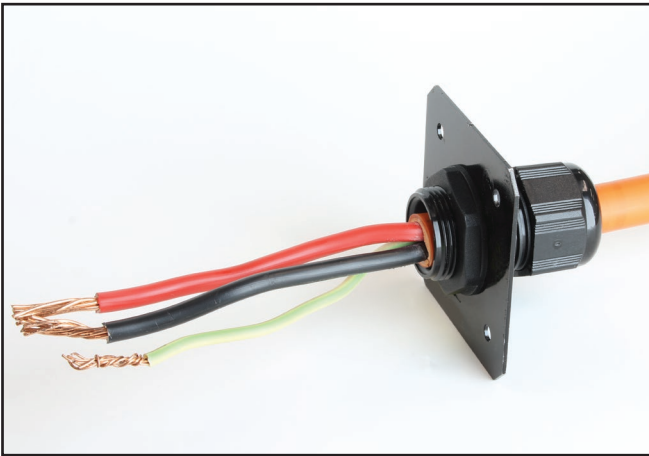

Figure S7 – Pre-assembling the Cable, Gland, Gland Plate and Mounting Gasket

8. Connect the generator's active, neutral and earth wires to the corresponding cable conductors using your preferred method, e.g. crimp fittings, screw connectors, soldering, etc. See Figure S8.

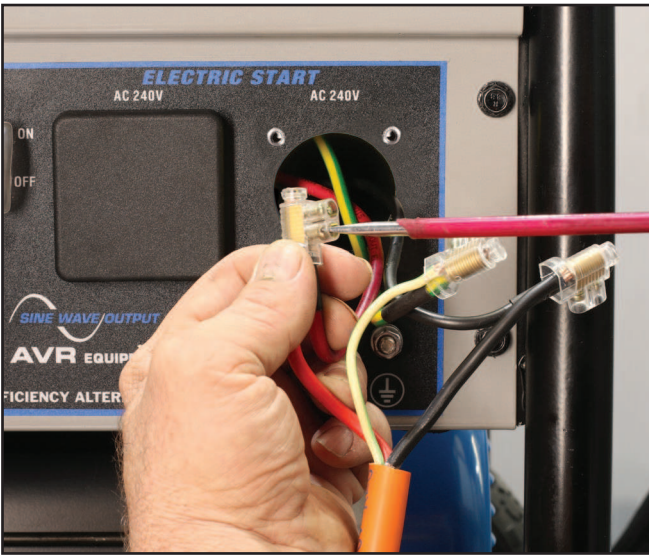

Figure S8 – Connecting the Cable

9. Adjust the position of the cable within the gland so that only a minimum length of cable will protrude into the control panel and then tighten the gland by hand or with a tool as appropriate. Apply a small continuous bead of silicone sealant around the circumference of the gland plate on the face that will abut the control panel. Align the gland plate's mounting holes with the socket mounting holes in the control panel and then affix the plate using the screws and washers supplied in the cable gland plate kit (see Figure S9). Wipe off any excess sealant from around the gland plate.



Figure S9 – Affixing the Gland Plate to the Control Panel

10. The other end of the cable MUST be safely terminated BEFORE the generator can be returned to operation as described below in Step 11. According to the application, for example, the other end of the cable may be terminated in a 32 A socket, changeover / isolating switch, circuit breaker or switchboard.

11. Reconnect the generator's battery cables to the battery starting with the positive (+) cable first. Re-attach the spark plug boot to the spark plug. Plug in any electrical cord or appliance to the left-hand-side 240-Volt AC socket and also to the 12-Volt DC socket, as required (see Figure S10).

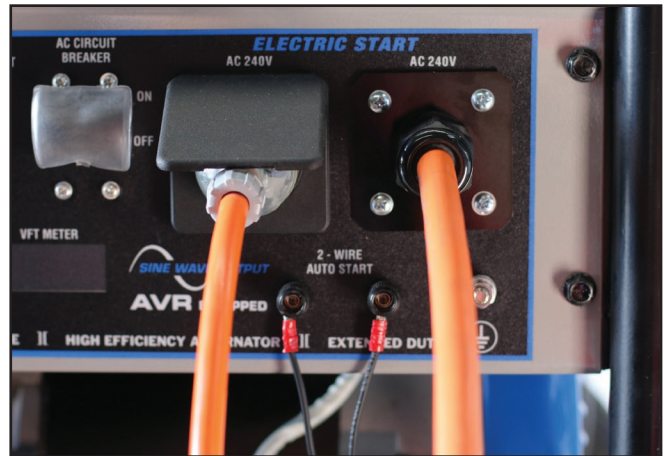

Figure S10 – 240 Volt AC Detachable Plug & Socket Connection (Left) and Direct Connection (Right)

The generator is now ready for operation as described in the main Instruction Manual.



Westinghouse

INNOVATION YOU CAN BE SURE OF

Westinghouse Outdoor Power Equipment

21 Resource Street
Parkinson QLD 4115 Australia
westinghouseoutdoorpower.com.au

© 2023 All rights reserved. Content may change without notice.
™, Westinghouse, and INNOVATION YOU CAN BE SURE OF
are trademarks of the Westinghouse Electric Corporation used
under license by Westinghouse Outdoor Power Equipment.
All rights reserved.