

Portable Generator Instruction Manual

WHXC3750

WHXC3750-PRO

WHXC5000

WHXC7000

WHXC8500E

WHXC8500E-PRO

WHXC8500E-AS



Westinghouse

INNOVATION YOU CAN BE SURE OF



CONGRATULATIONS ON PURCHASING A WESTINGHOUSE PORTABLE GENERATOR

Thank you for purchasing a Westinghouse portable generator. It is a high quality power product that will provide many years of safe and reliable service if properly operated and maintained.

DANGER



This manual contains important instructions for operating the generator. For your safety and that of others, be sure to read this manual thoroughly before operating the generator. Failure to properly follow all instructions and precautions can cause you and others to be seriously hurt or killed. This manual should be considered a permanent part of the generator and should remain with it if resold.

For Your Records:

Date of Purchase: _____ Generator Model Number: _____

Purchased from Store/Dealer: _____ Generator Serial Number: _____

Purchase Receipt: (Please retain your tax invoice or purchase receipt to ensure warranty coverage.)

DISCLAIMERS:

All instructions, illustrations and specifications in this manual are based on the latest information available at the time of publishing. The illustrations used in this manual are intended as representative reference views only. Moreover, because of our continuous product improvement policy, we may modify information, illustrations or specifications to explain or exemplify a product, service or maintenance improvement. We reserve the right to make any change at any time without notice. Your generator may differ slightly from the models pictured, including optional accessories.

ALL RIGHTS RESERVED:

No part of this publication may be reproduced or used in any form by any means – graphic, electronic or mechanical, including photocopying, recording, taping or information storage and retrieval systems – without the written permission of Westinghouse Outdoor Power Equipment.



Westinghouse

CONTENTS

SAFETY	1
SAFETY DEFINITIONS.....	1
SAFETY SYMBOL DEFINITIONS.....	1
GENERAL SAFETY RULES.....	2
SAFETY LABELS	4
UNPACKING	6
UNPACKING THE GENERATOR.....	6
WHEEL KIT	6
ASSEMBLY	7
WHEEL KIT ASSEMBLY.....	7
INSTALLING THE BATTERY (ELECTRIC START GENERATORS ONLY).....	9
FEATURES	10
MAIN GENERATOR COMPONENTS	10
CONTROL PANELS	12
OPERATION	15
BEFORE STARTING THE GENERATOR.....	15
CHECKING / ADDING ENGINE OIL AND FUEL	16
Checking and Adding Engine Oil.....	16
Checking and Adding Fuel	16
STARTING THE GENERATOR	17
Manually Starting a Generator	17
Starting an Electric Start Generator (Models WHXC8500E & WHXC8500E-PRO).....	19
Local Electric Starting of the WHXC8500E-AS	20
Automatic Electric Starting of the WHXC8500E-AS by 2-Wire Remote Control.....	20
STOPPING THE GENERATOR.....	21
Normal Operation (except WHXC8500E-AS in Auto-Start Mode).....	21
Normal Operation (WHXC8500E-AS in Auto-Start Mode)	22
During an Emergency	22
APPLICATION AND DUTY CYCLE.....	22
AMBIENT CONDITIONS	22
CONNECTING ELECTRICAL LOADS	22
240-Volt AC Loads	22
12-Volt DC Loads	23
Power Output and Demand.....	23
240-VOLT AC EXTENSION CORDS.....	24
12 VOLT BATTERY CHARGING	25
Battery Charging by Direct Connection.....	25
Battery Charging by a Mains-Powered Charger	25
TRANSPORTING THE GENERATOR	26

CONTENTS

MAINTENANCE	27
MAINTENANCE PRECAUTIONS	27
Maintenance Schedule.....	27
ENGINE OIL MAINTENANCE.....	28
Engine Oil Specification	28
Checking Engine Oil	28
Adding Engine Oil.....	29
Changing Engine Oil.....	29
AIR FILTER MAINTENANCE	29
Cleaning the Air Filter (Models WHXC3750 & WHXC3750-PRO)	30
Cleaning the Air Filter (Models WHXC5000, WHXC7000, WHXC8500E / PRO / AS)	31
FUEL STRAINER MAINTENANCE.....	32
FUEL SEDIMENT CUP MAINTENANCE	33
SPARK PLUG MAINTENANCE	34
SPARK ARRESTER MAINTENANCE	35
CLEANING THE GENERATOR.....	36
RCD SAFETY SWITCH TESTING (IF SO EQUIPPED).....	37
12 VOLT BATTERY MAINTENANCE (IF SO EQUIPPED).....	37
Battery Bulk Charging	38
Battery Maintenance Charging.....	38
Replacing the Battery	38
DRAINING THE FUEL	39
LONG-TERM STORAGE	39
Storage Procedure for 1 – 3 Months	40
Storage Procedure for Greater than 3 Months.....	40
Removal from Storage.....	40
DISMANTLING AND DISPOSAL.....	40
TROUBLESHOOTING	41
SPECIFICATIONS	45
WIRING DIAGRAMS	46
WHXC3750 WIRING DIAGRAM.....	46
WHXC3750-PRO WIRING DIAGRAM	47
WHXC5000 WIRING DIAGRAM.....	48
WHXC7000 WIRING DIAGRAM.....	49
WHXC8500E WIRING DIAGRAM.....	50
WHXC8500E-PRO WIRING DIAGRAM.....	51
WHXC8500E-AS WIRING DIAGRAM.....	52
WARRANTY	53
WARRANTY AGAINST DEFECTS.....	53
Proof of Purchase	53
Warranty Conditions	53

SAFETY

SAFETY DEFINITIONS

The words DANGER, WARNING, CAUTION and NOTICE are used throughout this manual to highlight important information. Be certain that the meanings of these alerts are known to all who work on or near the equipment.



This safety alert symbol appears with most safety statements. It means attention, become alert, your safety is involved! Please read and abide by the message that follows the safety alert symbol.

 DANGER
 Indicates a hazardous situation which, if not avoided, *will* result in death or serious injury.

 WARNING
 Indicates a hazardous situation which, if not avoided, *could* result in death or serious injury.

 CAUTION
 Indicates a hazardous situation which, if not avoided, *could* result in minor or moderate injury.

NOTICE
 Indicates a situation which can cause damage to the generator, personal property or the environment, or cause the equipment to operate improperly.

NOTE: Indicates a procedure, practice or condition that should be followed in order for the generator to function in the manner intended.

SAFETY SYMBOL DEFINITIONS

Symbol	Description
	Safety Alert Symbol
	Asphyxiation Hazard
	Burn Hazard
	Burst / Pressure Hazard
	Don't leave tools in the area
	Electrical Shock Hazard
	Explosion Hazard
	Fire Hazard
	Lifting Hazard
	Pinch-Point Hazard
	Read Manufacturer's Instructions
	Wear Personal Protective Equipment (PPE)
	Read Safety Messages Before Proceeding

GENERAL SAFETY RULES

DANGER



Never use the generator in a location that is wet or damp. Never expose the generator to rain, snow, water spray or standing water while in use. Protect the generator from all hazardous weather conditions. Moisture or ice can cause a short circuit or other malfunction in the electrical system.



Never operate the generator in an enclosed area. Engine exhaust contains carbon monoxide. Only operate the generator outside and away from windows, doors and vents.

WARNING



Voltage produced by the generator could result in death or serious injury.

- Never operate the generator in rain or a floodplain unless proper precautions are taken to avoid being subject to rain or flood.
- Never use worn or damaged extension cords.
- Always have a licensed electrician connect the generator to any fixed electrical installation.
- Never touch an operating generator if the generator is wet or if you have wet hands.
- Never operate the generator in highly conductive areas such as around metal decking or steel works.
- Always use earthed extension cords. Always use three-wire or double-insulated power tools.
- Never touch live terminals or bare wires while the generator is operating.
- Keep animals and children away from the generator at all times.

WARNING



Petrol fuel liquid and vapours are extremely flammable and explosive under certain conditions.



- Always refuel the generator outdoors, in a well-ventilated area.
- Never remove the fuel cap while the engine is running.
- Never refuel the generator while the engine is running. Always turn engine off and allow the generator to cool before refuelling.
- Only fill fuel tank with unleaded petrol.
- Keep away from sparks, open flames or other forms of ignition such as matches, cigarettes, CB radios and mobile phones when refuelling.
- Never overfill the fuel tank. Leave room for fuel to expand. Overfilling the fuel tank can result in a sudden overflow of fuel and result in spilled fuel coming in contact with hot surfaces. Spilled fuel can ignite. If fuel is spilled on the generator, wipe it up immediately and dispose of rags properly. Allow area of spilled fuel to dry before operating the generator.
- Wear eye protection while refuelling.
- Never use fuel as a cleaning agent.
- Store any fuel containers in a well-ventilated area, away from any combustibles or source of ignition.
- Check for fuel leaks after refuelling. Never operate the engine if a fuel leak is discovered.
- Equip the operating area with a Class ABE or BE portable fire extinguisher.



SAFETY

⚠️ WARNING



Never operate the generator if: powered items overheat; electrical output drops; there are sparks, flames or smoke coming from the generator; or if the receptacles are damaged.



Never attempt to connect more than one generator to the same electrical device, extension cord or fixed electrical installation.



Never use the generator to power medical support equipment.



Always remove any tools or other service equipment used during maintenance before operating the generator.

⚠️ WARNING



Do not operate in a hazardous location, e.g. where there may be a risk of explosion of petrol fumes, leaking gas or explosive dusts.



Do not operate in a confined area where exhaust gases, smoke or fumes could reach dangerous concentrations.



Do not refuel while engine is running.

⚠️ WARNING



The generator may start without warning when it is in auto-start mode with 2-wire remote control active, if so equipped.

Never leave the generator on standby in auto-start mode, if so equipped, unless intentionally required.

⚠️ WARNING



You must take reasonable care for the health and safety both of yourself and any others who may be affected by your actions. You must understand and follow all of the safety rules and working instructions described herein. You must also use your own good judgement and common sense.

NOTICE

Never modify the generator.

Never operate the generator if it vibrates at high levels, if the engine speed changes greatly or if the engine misfires often.

Always disconnect electric tools or appliances from the generator before starting.

SAFETY LABELS

The safety labels have specific positions and must be replaced if they are unreadable, damaged or missing (see Figures 1 and 2).



1

<p>MAINTAIN AIR FILTER</p> <p>Rinse with cleaning solvent and dry once every 50 hours (every 10 hours if operating in dusty conditions) and then coat with clean engine oil. Squeeze out excess oil.</p>	<p>FUEL</p> <p>OFF / ON</p>
---	-----------------------------

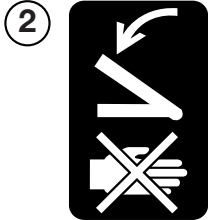

3

CHOKE	
ON	OFF

4

⚠ DANGER		
USING A GENERATOR INDOORS CAN KILL YOU IN MINUTES. GENERATOR EXHAUST CONTAINS CARBON MONOXIDE. THIS IS A POISON YOU CANNOT SEE OR SMELL.		
NEVER USE INSIDE A HOME OR GARAGE, EVEN IF DOORS AND WINDOWS ARE OPEN.		ONLY USE OUTSIDE AND FAR AWAY FROM WINDOWS, DOORS, AND VENTS.

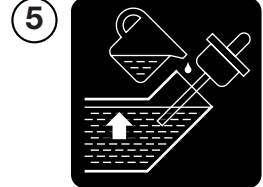

Figure 1 - Safety Labels (Front, Left Side & Top)

SAFETY



1 **⚠ DANGER**
 Read the Instruction Manual before operating the generator. Failure to follow all instructions may cause death, serious injury or property damage. Do not operate in a hazardous location, e.g. where there may be a risk of explosion of petrol fumes, leaking gas or explosive dusts. Do not operate in a confined area where exhaust gases, smoke or fumes could reach dangerous concentrations. Do not refuel while engine is running. Do not operate in a location that is wet or damp. **Warning: The output of this generating set is potentially lethal. The set shall not be connected to a fixed electrical installation by fixed wiring except by an appropriately licensed person. See Instruction Manual.**

2 **⚠ WARNING HOT SURFACES**  **⚠ WARNING HOT SURFACES**

3

 Westinghouse <small>Westinghouse Outdoor Power Equipment, LLC 777 Manor Park Drive, Columbus OH 43228 USA westinghouseoutdoorpower.com.au</small>	Model Number	WHXC8500E-PRO	Protection	IP23	Serial Number
	Part Number	10692		N15626	
	AC Voltage	240 V	Rated Power	6750W	
	AC Frequency	50 Hz	Starting Power	8500W	
	AC Outlet	15 A, Type I	Fuel	Unleaded Petrol	

Made in China

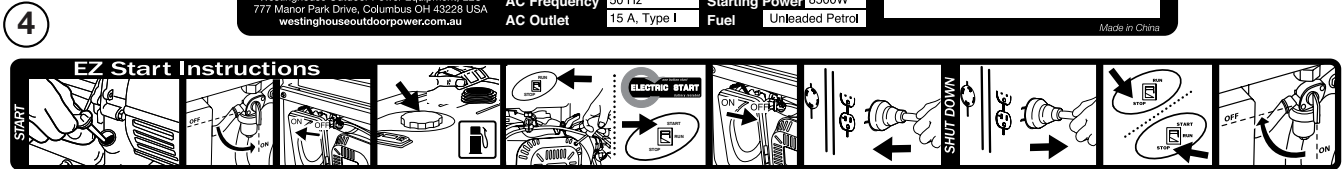

Figure 2 - Safety Labels (Rear & Right Side)

UNPACKING THE GENERATOR

CAUTION



Always have assistance when lifting the generator. The generator is heavy; lifting it could cause bodily harm.



Avoid cutting on or near staples to prevent personal injury.

1. Carefully cut the packing tape on top of the carton.
2. Fold back top flaps to reveal the Instruction Manual lying on top of the unit. Remove the manual and save it for reference.
3. Remove the Wheel Kit.
4. Carefully cut down along the four vertical corners of the carton and fold the sides flat onto the ground.
5. Locate and remove the oil bottle, oil funnel and tool bag (with spark plug socket wrench enclosed) that are packed in together with the generator.
6. Proceed with attachment of the wheel kit components.
7. Lift and move the generator off the carton and then recycle or dispose of the packaging materials properly.

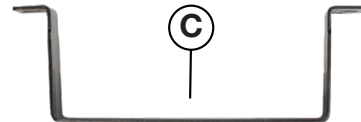
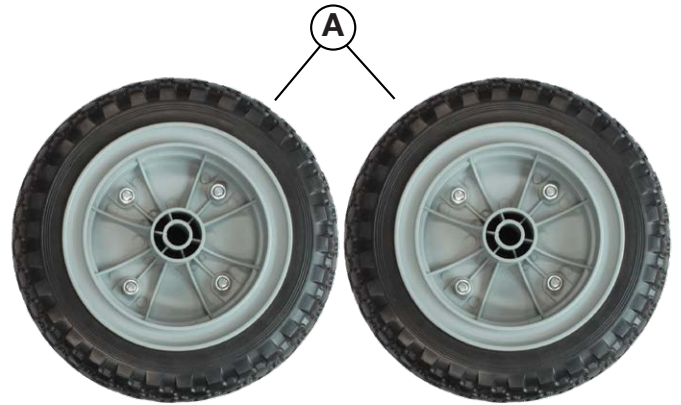

WHEEL KIT

Check the wheel kit and verify its components against those shown in *Figure 3*. If any parts are missing, please contact your local Westinghouse dealer.

- A – Wheel (Qty 2)
- B – Handle with Grip (Qty 2)
- C – Mounting Foot (Qty 1)
- D – Axle (Qty 2)
- E – Clevis Pin (Qty 2)
- F – Bolt M6 x 18 mm (Qty 2)
- G – Nut M6 (Qty 2)
- H – Bolt M8 x 16 mm (Qty 2)
- I – Nut M8 (Qty 2)
- J – Rubber Pad (Qty 2)
- K – Cotter Pin (Qty 4)

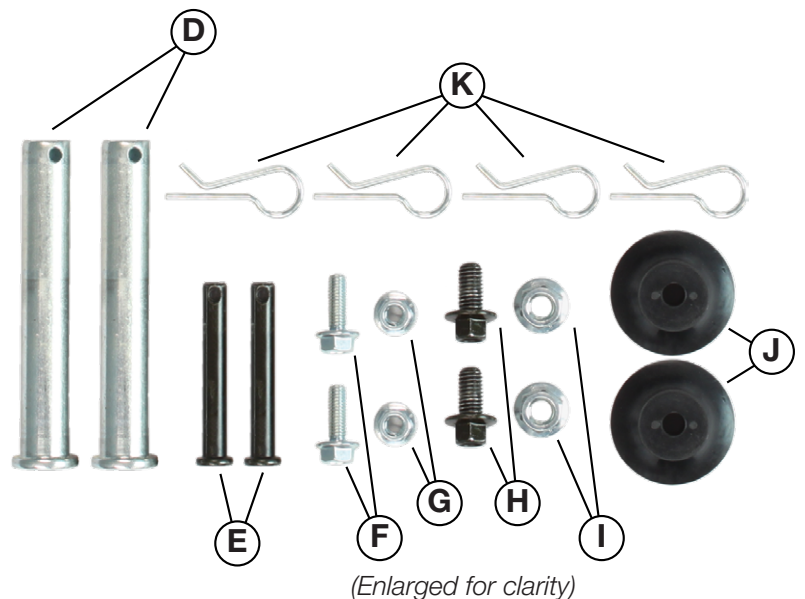

Figure 3 - Wheel Kit Components

ASSEMBLY

WHEEL KIT ASSEMBLY

CAUTION



Never lift the generator without assistance. The generator is heavy and lifting without assistance could result in personal injury.



Never use the handles as a lifting point to support the entire weight of the generator. Only use the handles to lift one end of the generator and then move it around on its wheels.



Use caution when collapsing the handles. Hands or fingers could get caught and pinched.

NOTICE

Assembling the generator will require lifting the unit on one side. Make sure all engine oil and fuel are drained from the unit prior to assembling.

Once assembled, the wheel kit is not intended for towing the generator either on or off-road. The wheel kit is designed for use on this generator only.

Tools required (not included) – 10 mm spanner (Qty 2) and 13 mm spanner (Qty 2).

1. Place generator on a flat surface.
2. Place a piece of cardboard or other soft material to tip the generator onto, to protect the frame paint and prevent the generator from sliding. Tip the generator onto its side as shown in *Figure 4* with the engine at the bottom.
3. Attach the rubber pads onto the mounting foot using the M6 bolts and nuts as shown in *Figure 5*.



Figure 4 - Tip the Generator onto its Side

1. Attach the mounting foot to the frame using the M8 bolts and nuts.

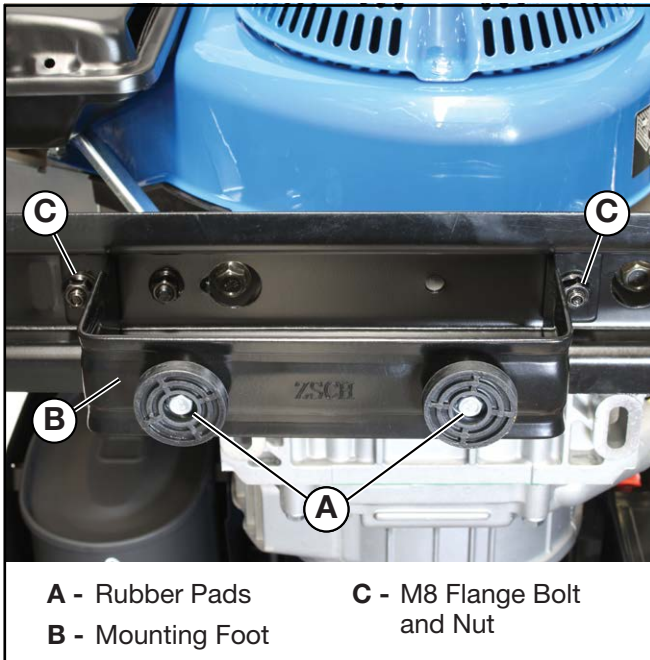

Figure 5 – Attaching Mounting Foot to Frame

2. Insert an axle through one of the wheels from the recessed hub side. Then insert the protruding axle through one of the axle brackets on the frame beside the engine.
3. Insert the straight leg of one cotter pin through the hole in the end of the axle as shown in *Figure 6*.

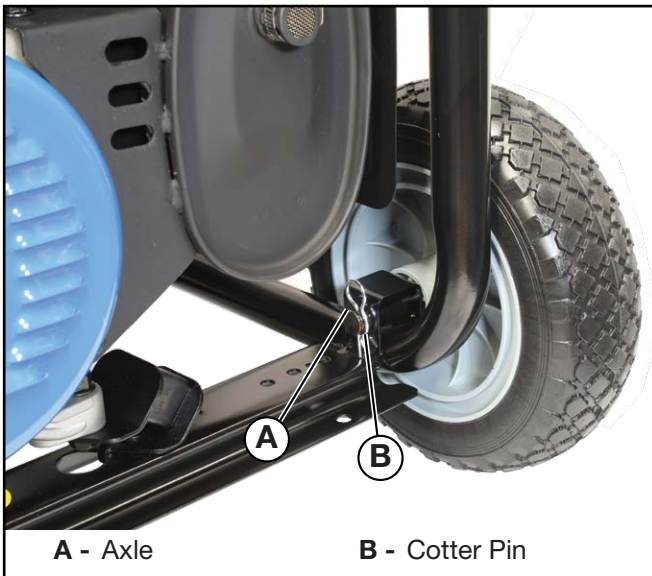

Figure 6 – Attaching Wheel to Frame

4. Repeat steps 2 and 3 using the other axle, wheel and cotter pin.
5. Install each handle using a clevis pin and cotter pin as shown in *Figure 7*.

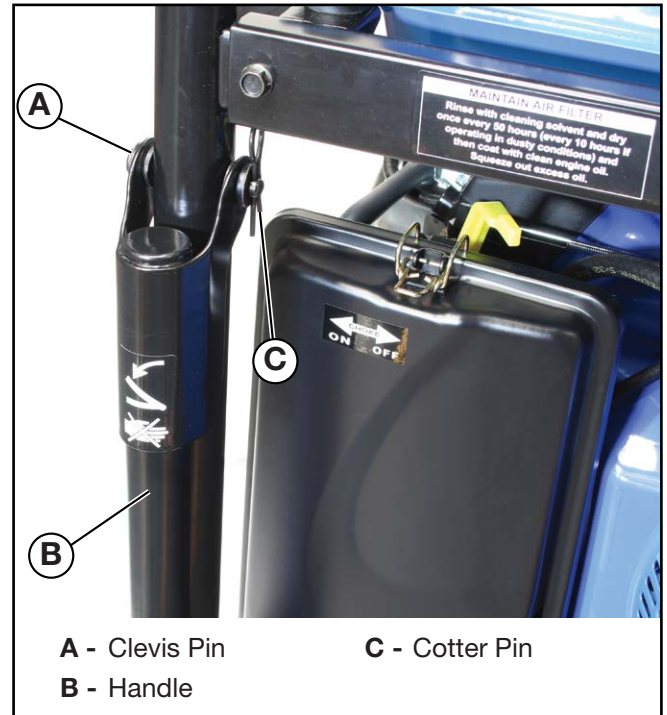

Figure 7 – Attaching Handle to Frame

ASSEMBLY

INSTALLING THE BATTERY (ELECTRIC START GENERATORS ONLY)

WARNING



To avoid electric shock:

- ALWAYS connect the positive (+) battery cable (red boot) first when connecting battery cables.
- ALWAYS disconnect the negative (-) battery cable (black boot) first when disconnecting battery cables.
- NEVER connect the negative (-) battery cable (black boot) to the positive (+) terminal on the battery.
- NEVER connect the positive (+) battery cable (red boot) to the negative (-) terminal on the battery.
- NEVER touch both battery terminals simultaneously.
- NEVER place a tool or other metal object across both battery terminals.
- NEVER place a tool or other metal object between either of the battery terminals and any part of the generator.
- ALWAYS use insulated or non-conducting tools when installing the battery.

NOTE: The generator comes equipped with the positive battery cable (red boot) already attached.

Tools required (not included) – 10 mm spanner.

1. Verify the positive (+) battery cable (red boot) is securely tightened to the positive (+) battery terminal. Ensure boot is properly fitted over battery terminal.
2. Carefully remove the protective wrapping around the lug of the negative (-) battery cable (black boot).
3. Remove the temporary cable tie on the negative (-) cable and then route the cable towards the negative (-) battery terminal.
4. Pull back the black boot and securely attach the negative (-) battery cable (black boot) to the negative (-) battery terminal as shown in *Figure 8*. Replace the black boot so it protects the cable lug and battery terminal.

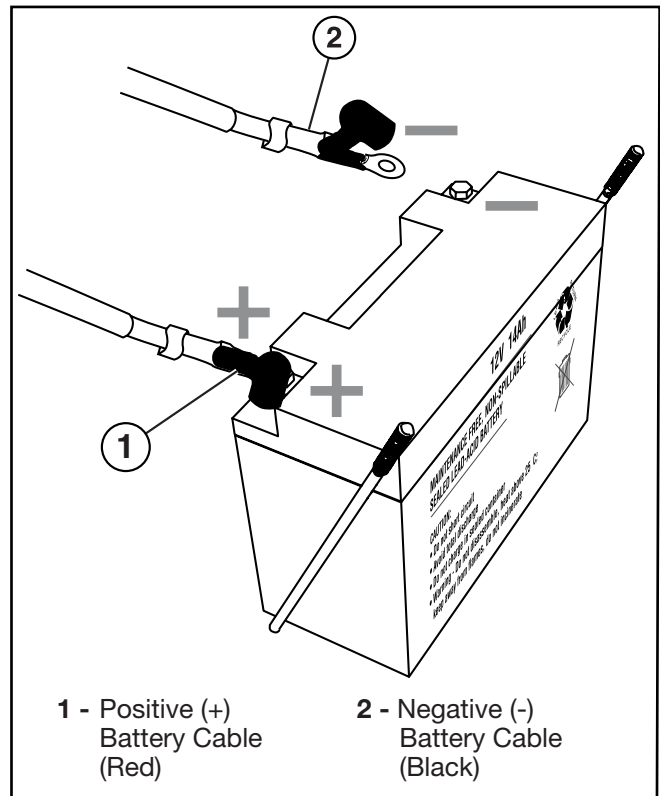

Figure 8 – Attaching the Negative (-) Battery Cable (Black) to the Negative (-) Battery Terminal

MAIN GENERATOR COMPONENTS

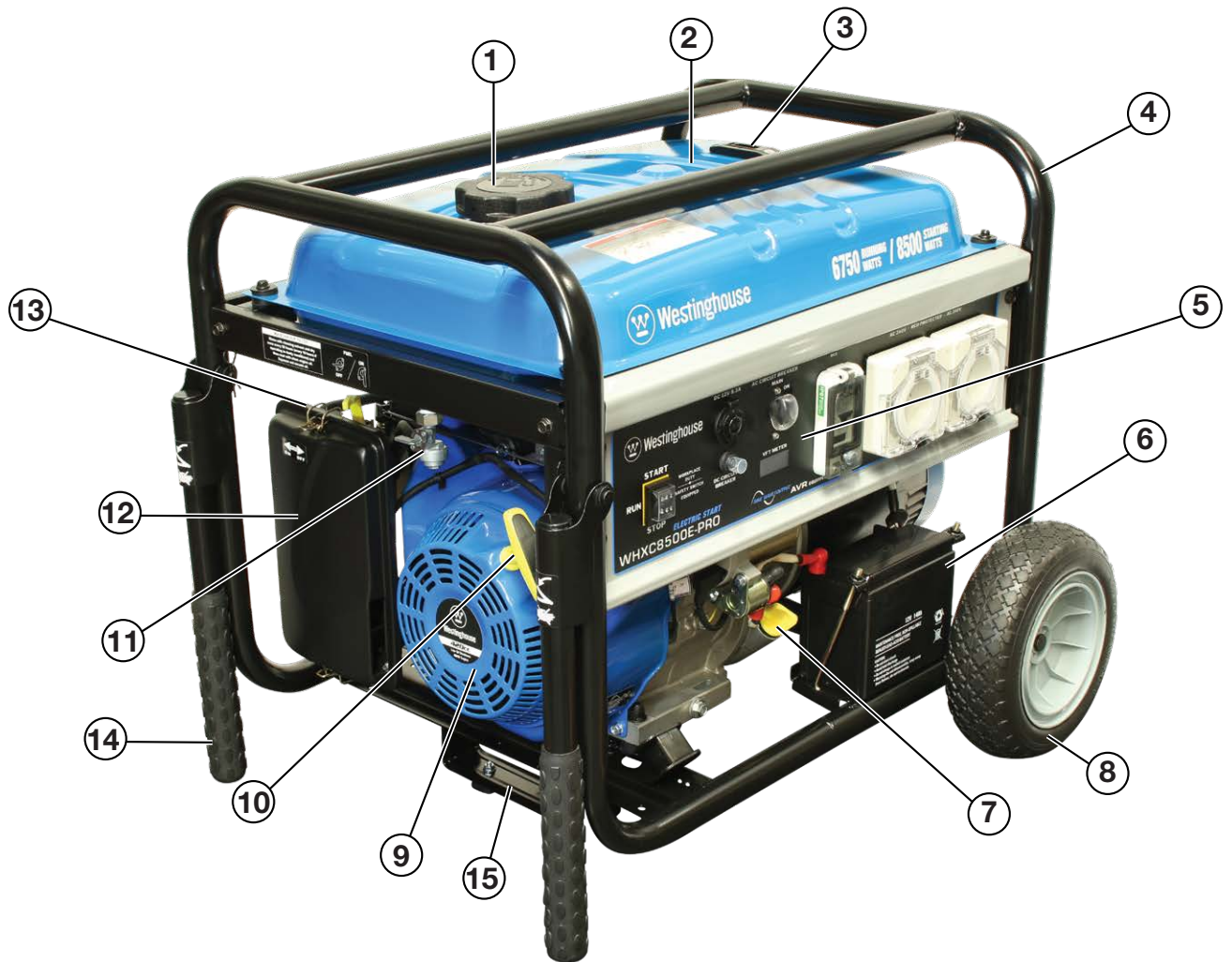

Figure 9 - Main Generator Components (Front, Left Side & Top)

- | | |
|------------------------------|----------------------------|
| 1 - Fuel Cap | 8 - Wheel |
| 2 - Fuel Tank | 9 - Engine |
| 3 - Fuel Gauge | 10 - Recoil Starter Handle |
| 4 - Frame | 11 - Fuel Shutoff Valve |
| 5 - Control Panel | 12 - Air Filter |
| 6 - Battery (if so equipped) | 13 - Choke Lever |
| 7 - Oil Fill Plug/Dipstick | 14 - Handle |
| | 15 - Mounting Foot |

FEATURES



Figure 10 - Main Generator Components (Rear & Right Side)

1 - Muffler

2 - Alternator

3 - Spark Plug

4 - Carburettor

5 - Spark Arrester

CONTROL PANELS

WHXC3750, 5000 & 7000



WHXC8500E



WHXC3750 - PRO



Figure 11 – Control Panel Features (continued over page)

FEATURES

WHXC8500E-PRO



WHXC8500E-AS



Figure 11 – Control Panel Features

- 1A. Engine Control Switch (RUN / STOP):**
- **RUN** - In the **RUN** position, the switch allows the generator to be started.
 - **STOP** - In the **STOP** position, the switch stops the engine.

- 1B. Engine Control Switch (START / RUN / STOP):**
- **START** - When the switch is momentarily depressed and held in the **START** position,

the electric starter motor engages and starts the engine. Once the engine starts, release the switch. The switch will then automatically return to the **RUN** position.

- **RUN** - Once started, the switch will remain in the **RUN** position.
- **STOP** - To stop the engine, move the switch to the **STOP** position.

1C. Engine Control Switch (START / AUTO RUN / STOP):

- **START** – When the switch is momentarily turned and held in the **START** position while the auto start control switch is in the **OFF** position, the electric starter motor engages and starts the engine. Once the engine starts, release the switch and it will automatically return to the **AUTO RUN** position.
 - **AUTO RUN** – Once the engine is started locally using either the electric or recoil starter, the switch will remain in the **AUTO RUN** position. The engine can also be started and stopped automatically by 2-wire remote control when the engine control switch is in the **AUTO RUN** position and the auto start control switch is in the **ON** position.
 - **STOP** – To stop the engine, turn the switch to the **STOP** position.
2. **12-Volt DC Accessory Socket:** Can be used for 12-Volt DC powered devices. Maximum output 8.3 Amps (100 Watts).
 3. **Main 240-Volt AC Circuit Breaker:** Protects the generator against overload or short circuit of the 240-Volt AC system, and can also be used to switch the generator's entire AC output on or off. The switch will automatically move to the **OFF** position in the event of a fault and must be manually reset when safe to do so after reducing the applied load or rectifying the electrical fault.
 4. **Residual Current Device (RCD) Safety Switch (if so equipped):** Designed to protect the user against electric shock by disconnecting all 240-Volt AC outlets in the event of a detected current leakage. The switch will automatically move to the **OFF** position in the event of a fault and must be manually reset when safe to do so after rectifying the electrical fault.
 5. **240-Volt AC, 15-Amp Outlet(s):** Each outlet is capable of delivering the generator's full output or 15 Amps (3,600 Watts), whichever is the lesser.
 6. **Frame Terminal:** The frame terminal can be used by a licensed electrician to earth the generator if necessary.
 7. **VFT Meter:** Continuously displays the generator's AC output voltage, AC output frequency and cumulative running hours in a repetitive sequence when the generator is running.
 8. **12-Volt DC Circuit Breaker:** Protects the generator against overload or short circuit of the 12-Volt DC system. The push button will automatically extend out from the control panel in the event of a fault and must be manually pushed back in to reset when safe to do so after reducing the applied load or rectifying the electrical fault.
 9. **Auto Start Control Switch:** In the **ON** position, the generator's 2-wire remote control function is activated; the generator can be started and stopped automatically by closing or opening an external voltage-free circuit connected to the 2-wire auto start terminals (see Item 12 below). In the **OFF** position, the generator's 2-wire remote control function is deactivated; the generator can only be started locally using either the electric or recoil starter.
 10. **Auto Start Active Indicator:** The green status light will illuminate whenever the engine control switch is in the **AUTO RUN** position and the auto start control switch is in the **ON** position. It serves to caution the user or others that the 2-wire remote control function is active and the generator may start or stop automatically without warning.
 11. **Auto Start Fault Indicator:** The red status light will flash on and off if the engine fails to start automatically after six attempts when in auto-start mode. The underlying cause of the fault must be rectified before resetting this indicator light by toggling either the engine control switch to the **STOP** position or the auto start control switch to the **OFF** position.
 12. **2-Wire Auto Start Terminals:** To utilise the 2-wire remote control feature, connect an external "dry" (i.e. voltage free) circuit to start the generator by closing the circuit or stop the generator by opening the circuit. Devices such as bi-directional battery power converters as used in stand-alone off-grid solar power systems can typically output such a 2-wire start / stop signal to control a backup generator.



OPERATION

BEFORE STARTING THE GENERATOR

Location Selection – Before starting the generator, avoid exhaust and location hazards by verifying:

- You have selected a location to operate the generator that is outdoors and well ventilated.
- You have selected a location with a level and solid surface on which to place the generator.
- You have selected a location that is at least 1.8 m away from any building, other equipment or combustible material.
- If the generator is located close to a building, it is not located near any windows, doors or vents.

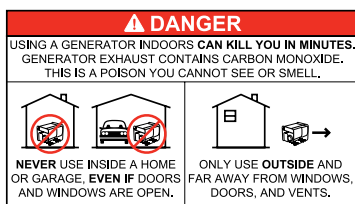

⚠ WARNING



Always operate the generator on a level surface. Placing the generator on non-level surfaces can cause the generator to tip over, causing fuel and oil to spill. Spilled fuel can ignite if it comes in contact with an ignition source such as a very hot surface.

NOTICE

Only operate the generator on a solid, level surface. Operating the generator on a surface with loose material such as sand or grass clippings can cause debris to be ingested by the generator that could:

- Block cooling vents
- Block air intake system

Weather – Never operate your generator outdoors during rain, snow or any combination of weather conditions that could lead to moisture collecting on, in or around the generator.

Dry Surface – Always operate the generator on a dry surface free of any moisture.

No Connected Loads – Except when using the WHXC8500E-AS model in auto-start mode with 2-wire remote control active, make sure the generator has no connected loads before starting it. To ensure there are no connected loads, unplug any electrical cords or devices from the 240-Volt AC and 12-Volt DC receptacles on the control panel. The main 240-Volt AC circuit breaker should also be switched to the **OFF** position.

NOTICE

Starting the generator with loads already connected to it could result in damage to any device being powered by the generator during the brief start-up period. This does not apply to the WHXC8500E-AS model when operated in auto-start mode.

Earthing the Generator – The generator’s equipotential bonding system including the frame terminal on the control panel (see Figure 12) should not be connected to the general mass of earth through a separate earth electrode. For more information, refer to AS/NZS 3010:2017 Electrical Installations – Generating Sets or consult a licensed electrician.

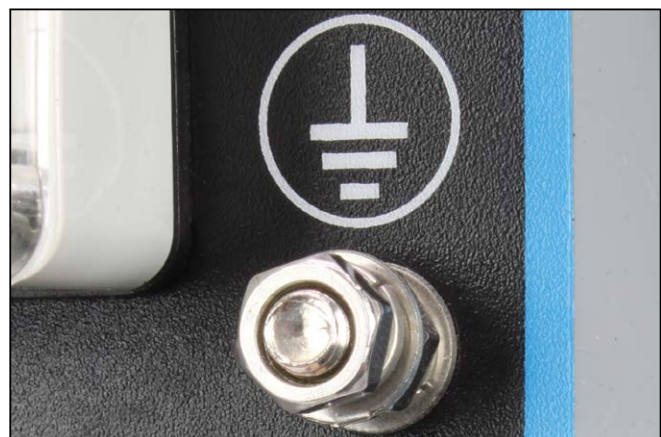



Figure 12 – Frame Terminal on the Control Panel

⚠ WARNING



Be sure the generator is properly installed before operating to reduce the possibility of electric shock. Generators equipped with a RCD Safety Switch offer much better protection against electric shock as mandated by Australian Workplace Health and Safety Regulations. Any connection to an electrical installation such as in a building, for example, must be carried out by a licensed electrician.

CHECKING / ADDING ENGINE OIL AND FUEL

DANGER



Filling the fuel tank with fuel while the generator is running can cause fuel to spill and come in contact with hot surfaces that can ignite the fuel.

Before starting the generator, always check the engine oil and fuel levels.

After starting the generator, it is not safe to add fuel to the fuel tank or engine oil to the engine while the engine is running or immediately after stopping while the engine and muffler are still hot.

Checking and Adding Engine Oil

WARNING



Internal pressure can build up in the engine crankcase while the engine is running. Removing the oil fill plug/dipstick while the engine is hot can cause extremely hot oil to spray out of the crankcase and can severely burn skin. Allow engine oil to cool for several minutes before removing the oil fill plug/dipstick.

The unit as shipped does not contain oil in the engine. You must add engine oil before starting the generator for the first time. See *Checking Engine Oil* and *Adding Engine Oil* for instructions on checking engine oil level and the procedure for adding engine oil.

NOTICE

The generator does not contain engine oil as shipped. Attempting to start the engine before adding engine oil can permanently damage internal engine components.

Checking and Adding Fuel

WARNING



Never refuel the generator while the engine is running.

For the WHXC8500E-AS model, always push the auto start control switch to the OFF position before refuelling.



Always turn the engine off and allow the generator to cool before refuelling.

With the generator switched off and stationary on a horizontal surface, check the fuel level as indicated on the fuel gauge. It is good practice to always fill the fuel tank before operating the generator.

Required Fuel – Use only unleaded petrol with an octane rating not less than 87 and ethanol content not greater than 10%. Where possible it is preferable to use regular unleaded petrol without ethanol.

Filling the Fuel Tank – Follow the steps below to fill the fuel tank:

1. Shut off the generator.
2. Allow the generator to cool down so all surface areas of the muffler and engine are cool to the touch.
3. Move the generator to a flat surface.
4. Clean area around the fuel cap.
5. Remove the fuel cap by unscrewing it anti-clockwise.
6. Slowly add fuel into the fuel tank. Be very careful not to overfill the tank. The fuel level should NOT be higher than the bottom of the filler neck (see *Figure 13*).
7. Replace the fuel cap by screwing it clockwise until a click is heard, indicating the cap is completely installed.

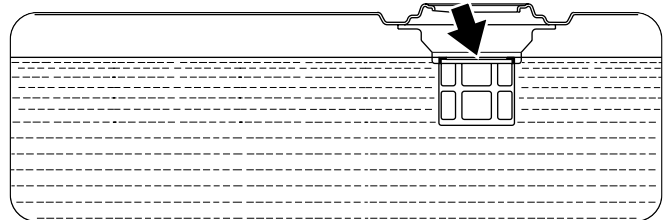

Figure 13 – Maximum Fuel Fill Level

CAUTION



Avoid prolonged skin contact with fuel. Avoid prolonged inhalation of fuel vapours.



OPERATION

STARTING THE GENERATOR

Before attempting to start the generator, verify the following:

- The engine is filled with engine oil (see *Checking Engine Oil*).
- The generator is situated in a proper location (see *Location Selection*).
- The generator is on a dry surface (see *Weather and Dry Surface*).
- All loads are disconnected from the generator and the AC circuit breaker is switched **OFF** (see *No Connected Loads*). This does not apply to the WHXC8500E-AS model when operated in auto-start mode.

⚠ DANGER



Never use the generator in a location that is wet or damp. Never expose the generator to rain, snow, water spray or standing water while in use. Protect the generator from all hazardous weather conditions. Moisture or ice can cause a short circuit or other malfunction in the electrical system.



Never operate the generator in an enclosed area. Engine exhaust contains carbon monoxide. Only operate the generator outside and away from windows, doors and vents.

NOTICE

The generator is equipped with a low oil shutdown switch. If the oil level becomes too low, the engine will shut down automatically and cannot be restarted until the oil is filled to the proper level.

Be sure the engine has the proper oil level before using. Failure to verify that the engine has the proper oil level could result in severe engine damage or shortening the life of the engine.

Manually Starting a Generator

NOTE: This procedure can also be used for an electric start generator.

1. Make sure the AC circuit breaker is properly set to the **OFF** position and the DC breaker is pushed in (see *Figure 14*).



Figure 14 – Circuit Breakers

2. For the WHXC8500E-AS model, push the auto start control switch to the **OFF** position (see *Figure 15*).



Figure 15 – Auto Start Control Switch in the OFF Position

3. Move the fuel shutoff valve to the **ON** position (see Figure 16).

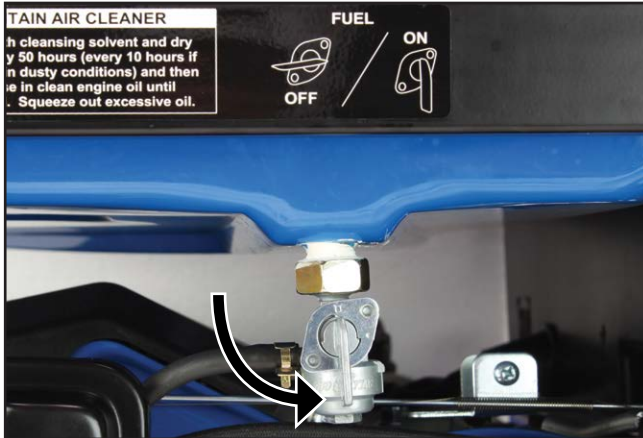
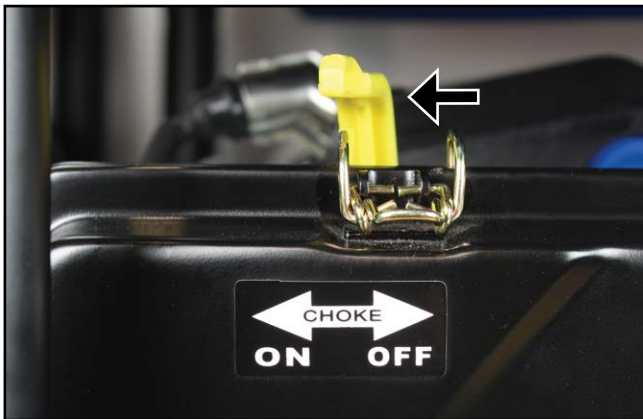

Figure 16 – Fuel Shutoff Valve in the ON Position

3. Move the choke lever to the **ON** position (see Figure 17) if starting a cold engine. To re-start a warm engine, leave the choke lever in the **OFF** position.

All models except WHXC8500E-AS



WHXC8500E-AS

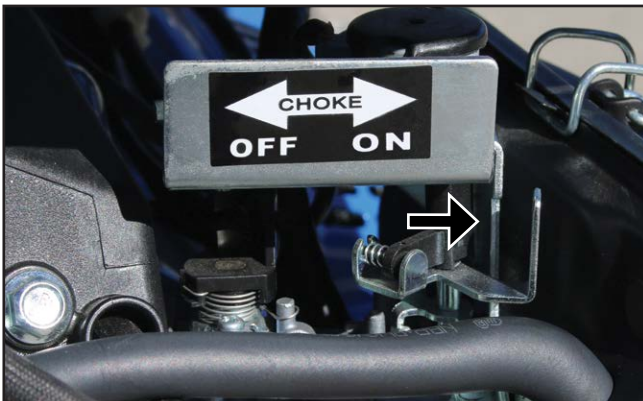

Figure 17 – Choke Lever in the ON Position

4. Push the engine control switch into the **RUN** position (see Figure 18). Or for the WHXC8500E-AS model, turn the engine control switch to the **AUTO RUN** position (see Figure 19).

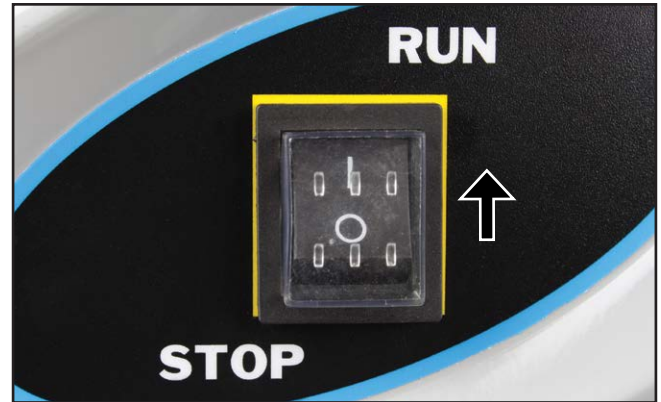

Figure 18 – Engine Control Switch in the RUN Position



Figure 19 - Engine Control Switch in the AUTO RUN Position

5. Firmly grasp the recoil starter handle and pull it slowly until you feel increased resistance. At this point, pull it briskly up and away from the generator (see Figure 20). Do not allow the starter handle to snap back against the engine, but instead return it gently to prevent starter damage. Do not allow the starter cord to rub against other parts of the generator.

OPERATION



Figure 20 – Recoil Starter Handle

- As the engine starts running and stabilises, gradually move the choke lever back to the **OFF** position.
- Connect electrical cords or devices into the 240-Volt AC or 12-Volt DC outlets, as required. Switch the 240-Volt AC Main Circuit Breaker to the **ON** position.

Starting an Electric Start Generator (Models WHXC8500E & WHXC8500E-PRO)

- Verify the battery is properly installed and both battery cables are attached (see *Installing the Battery*).
- Make sure the AC circuit breaker is properly set to the **OFF** position and the DC breaker is pushed in (see Figure 21).

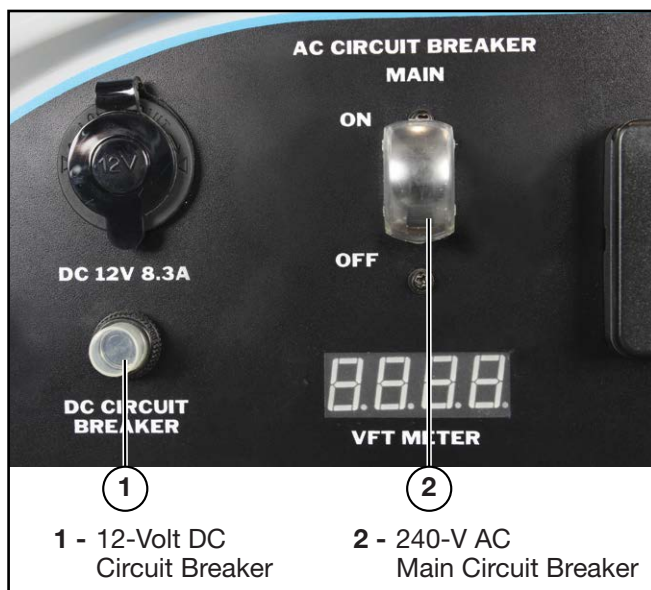

Figure 21 – Circuit Breakers

- Move the fuel shutoff valve to the **ON** position (see Figure 22).



Figure 22 – Fuel Shutoff Valve in the ON Position

- Move the choke lever to the **ON** position (see Figure 23) if starting a cold engine. To re-start a warm engine, leave the choke lever in the **OFF** position.

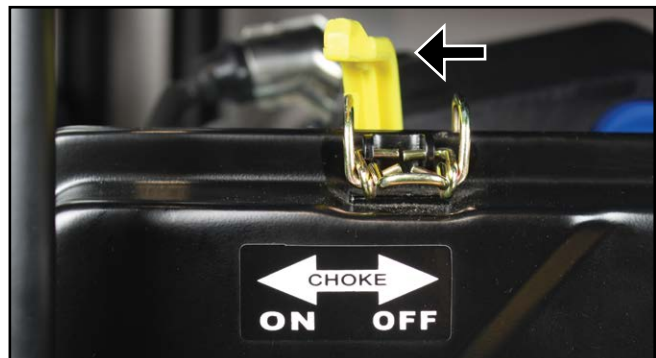

Figure 23 – Choke Lever in the ON Position

- Push and hold the engine control switch in the **START** position until the engine starts. Once the engine starts, release the engine control switch; the switch will automatically move into the central **RUN** position (see Figure 24).

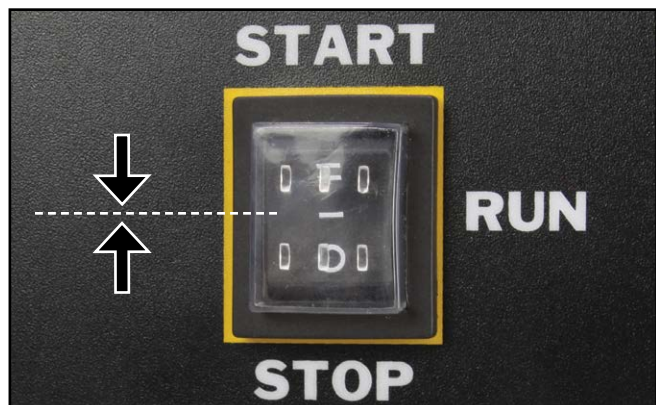

Figure 24 – Engine Control Switch in the RUN Position

NOTICE

Failure to release the engine control switch once the engine starts can result in damage to the generator. Never push the engine control switch to the **START** position while the engine is running; this can damage the generator.

NOTE: If the engine fails to start after 5 seconds, release the engine control switch. Let the generator rest for 15 seconds and then repeat step 5. If the cranking speed drops after each unsuccessful attempt, the battery may not be adequately charged; manually start the generator as instructed in *Manually Starting a Generator*.

NOTE: The electric start generator is equipped with a battery charging feature. Once the engine is running, a small charge is supplied to the battery via the battery cables and will slowly recharge the battery.

6. As the engine starts and stabilises, gradually move the choke lever back to the **OFF** position.
7. Connect electrical cords or devices into the 240-Volt AC or 12-Volt DC outlets, as required. Switch the 240-Volt AC Main Circuit Breaker to the **ON** position.

Local Electric Starting of the WHXC8500E-AS

1. Verify the battery is properly installed and both battery cables are attached (see *Installing the Battery*).
2. Make sure the AC circuit breaker is properly set to the **OFF** position and the DC breaker is pushed in (see *Figure 21*).
3. Move the fuel shutoff valve to the **ON** position (see *Figure 22*).
4. Do not touch the choke lever. It will automatically adjust itself to the correct position if the generator's battery is sufficiently charged.
5. Push the auto start control switch to the **OFF** position (see *Figure 15*).
6. Turn and hold the engine control switch in the **START** position until the engine starts. Once the engine starts, release the engine control switch; the switch will automatically move into the central **AUTO RUN** position (see *Figure 19*).

NOTICE

Failure to release the engine control switch once the engine starts can result in damage to the generator. Never turn the engine control switch to the **START** position while the engine is running; this can damage the generator.

NOTE: If the engine fails to start after 5 seconds, release the engine control switch. Let the generator rest for 15 seconds and then repeat step 6. If the cranking speed drops after each unsuccessful attempt, the battery may not be adequately charged; manually start the generator as instructed in *Manually Starting a Generator*.

NOTE: The electric start generator is equipped with a battery charging feature. Once the engine is running, a small charge is supplied to the battery via the battery cables and will slowly recharge the battery.

7. Connect electrical cords or devices into the 240-Volt AC or 12-Volt DC outlets, as required. Switch the 240-Volt AC Main Circuit Breaker to the **ON** position.

Automatic Electric Starting of the WHXC8500E-AS by 2-Wire Remote Control

1. Verify the battery is properly installed and both battery cables are attached (see *Installing the Battery*).
2. If the generator is left in non-operating standby whilst in auto-start mode for an extended period or it starts and stops frequently with a short operating time, the battery may become excessively discharged and unable to automatically start the generator. To ensure reliable service, it is recommended that the battery be connected in parallel to a mains or solar-powered automatic maintenance battery charger.
3. Connect electrical cords or devices into the 240-Volt AC or 12-Volt DC outlets, as required. Switch the 240-Volt AC Main Circuit Breaker to the **ON** position and ensure that the DC breaker is pushed in (see *Figure 21*).



OPERATION

4. Connect the 2-wire auto start terminals to an external “dry” or voltage-free circuit that will provide the start and stop commands to the generator by closing and opening the circuit, respectively (See Figure 25).

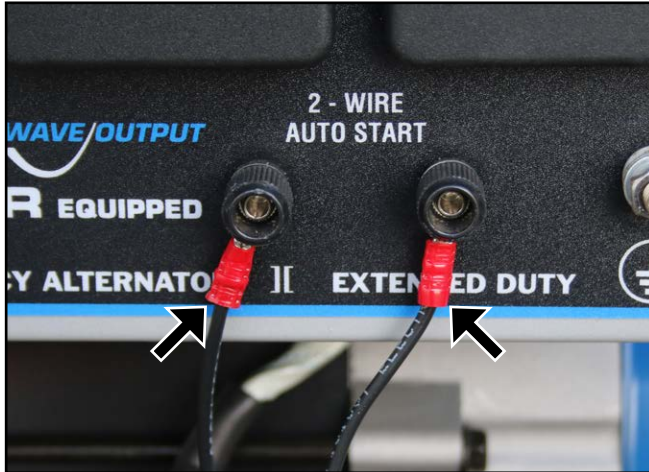

Figure 25 – Connection to the 2-Wire Auto Start Terminals

5. Move the fuel shutoff valve to the **ON** position (see Figure 22).
6. Do not touch the choke lever. It will automatically adjust itself to the correct position if the generator’s battery is sufficiently charged.
7. Turn the engine control switch to the **AUTO RUN** position (see Figure 19).
8. Push the auto start control switch to the **ON** position (see Figure 26) whereupon the green auto start active indicator light will illuminate.



Figure 26 – Auto Start Control Switch in the ON Position

9. Upon receiving a “start” signal by closing of the external 2-wire remote control circuit, the generator will start automatically, operate for 15 seconds without electrical output to allow the engine to warm up and stabilise, and then activate its electrical output. The generator will continue running until it receives a remote “stop” command, is manually stopped or runs out of fuel.

NOTICE

Never turn the engine control switch to the **START** position while the engine is running; this can damage the generator.

NOTE: If the engine fails to start automatically after six attempts or stops unexpectedly during operation, the auto start function is temporarily disabled and the red auto start fault indicator light will commence flashing on and off. Turn the engine control switch to the **STOP** position and push the auto start control switch to the **OFF** position before carrying out fault finding and rectification, for example by refuelling the generator if it has run of fuel. Then repeat the above starting procedure from Step 7 if still required.

NOTE: The electric start generator is equipped with a battery charging feature. Once the engine is running, a small charge is supplied to the battery via the battery cables and will slowly recharge the battery.

NOTE: If the generator is started manually with the recoil starter or electrically with the engine control switch while it’s in non-operating auto-start standby and without a remote “start” command via the 2-wire remote control circuit, it will operate for 7 seconds without electrical output and then stop automatically.

STOPPING THE GENERATOR

Normal Operation (except WHXC8500E-AS in Auto-Start Mode)

During normal operation, use the following steps to stop the generator:

1. Switch the 240-Volt AC Main Circuit Breaker to the **OFF** position. Unplug any electrical cords or devices from the 240-Volt AC and 12-Volt DC receptacles on the control panel.
2. Allow the generator to run unloaded for at least one minute to cool and stabilise the engine and alternator temperatures.

3. Push or turn the engine control switch to the **STOP** position.
4. Turn the fuel shutoff valve to the **OFF** position.

NOTICE

Stopping the generator (other than the WHXC8500E-AS model in auto-start mode) with electrical loads connected to it could result in damage to any device being powered by the generator during the brief shut down period. For the same reason, do not allow the generator to run out of fuel while it is operating.

Normal Operation (WHXC8500E-AS in Auto-Start Mode)

Upon receiving a “stop” signal by opening of the external 2-wire remote control circuit, the generator will automatically de-activate its electrical output, continue operating for 7 seconds to allow the engine to cool down and stabilise, and then stop. The generator will remain stopped in non operating standby condition until it receives a remote “start” command or is manually shut down.

To shut down the generator completely:

1. Turn the engine control switch to the **STOP** position and push the auto start control switch to the **OFF** position.
2. Turn the fuel shutoff valve to the **OFF** position.

During an Emergency

If there is an emergency and the generator must be stopped quickly, push or turn the engine control switch to the **STOP** position immediately.

APPLICATION AND DUTY CYCLE

All models within this range of Westinghouse generators are portable, air-cooled, petrol-engine driven, self-contained units designed for independent supply of electrical power. They are ideal as a backup power supply in the event of mains power failure or as a remote area power supply for use when camping, caravanning or working out in the field.

For most common applications, users can connect a Westinghouse generator to power electrical devices by detachable plug and socket-outlet connection as described in this manual. The RCD safety switch equipped models offer the best protection against electric shock when operated in this manner and their use is considered “best practice” according to Australian Workplace Health and Safety Regulations.

Westinghouse generators can also be connected to an electrical installation such as in a house or business premises, for example, by a licensed electrician. It should be noted that the RCD equipped models are not suitable for connection to a fixed multiple earthed neutral (MEN) electrical installation, which is the standard electrical distribution system used in Australia and New Zealand. This is because the RCD will trip on load due to the division of current between the neutral and earth conductors to the MEN installation.

The WHXC8500E-AS model has the added functionality of being able to be started and stopped automatically by 2-wire remote control, which makes it ideal for connection to off-grid solar power systems for automatic battery charging or power backup / boost.

AMBIENT CONDITIONS

The generator is designed to operate within the following range of ambient conditions:

- Temperature: -5 to +40°C
- Altitude: Up to 1,000 m

Where possible, the generator should be operated in the shade to prevent additional heat load due to solar radiation.

The engine’s power output will decrease by approximately 3.5% for each 300 m increase in altitude above sea level. This is normal for spark-ignition engines and is attributable to the decrease in atmospheric pressure (and thus the available air for combustion) as altitude increases.

CONNECTING ELECTRICAL LOADS

The generator can only be used to power 240-Volt AC, 50 Hz, single phase or 12-Volt DC electrical devices.

240-Volt AC Loads

240-Volt AC devices can be connected either directly or via electrical extension cords into the 240-Volt AC outlet(s) on the generator’s control panel. Lift up the spring-loaded weather resistant cover on each outlet for access to connect the electrical device or cord.

240-Volt AC devices may be fitted with either a three-pin 15 Ampere (typically abbreviated “15 Amp” or “15 A”) plug or a three-pin 10 Ampere (“10 Amp” or “10 A”) plug as shown in *Figure 27*. Certain double-insulated devices may be fitted with a two-pin 10 A plug that doesn’t have an earth pin (which is the longer, vertical pin).



OPERATION

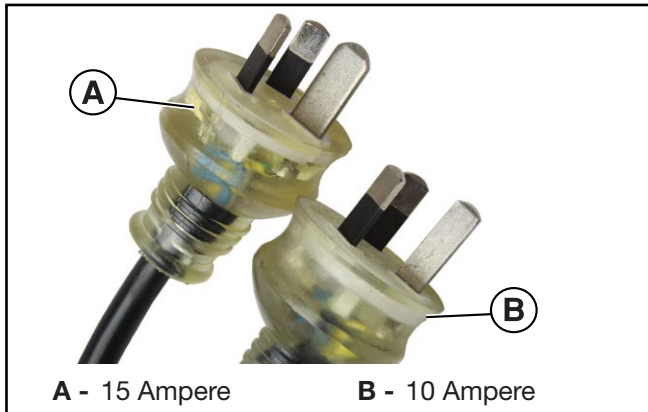

Figure 27 – 240-Volt AC Three-Pin Plugs

NOTICE

DO NOT connect any 240-Volt AC device that is fitted with a three-pin 20 A plug. This can overload the generator.

See *240-Volt AC Extension Cords* for detailed instructions concerning their selection and use.

12-Volt DC Loads

12-Volt DC devices can be connected either directly or via an electrical extension cord not exceeding 3.5 m in length into the 12-Volt DC outlet on the generator's control panel. Pull out the weather resistant stopper on the outlet for access to connect the electrical device or cord, and re-insert it after use.

NOTICE

The generator's 12-Volt DC electrical output is unregulated. DO NOT connect any 12-Volt DC device that may be damaged by voltage fluctuations.

12-Volt DC devices or extension cords must be fitted with a cigarette lighter plug for connection to the generator as shown in *Figure 28*.



Figure 28 – 12-Volt DC Cigarette Lighter Plug

WARNING



Never insert an automotive cigarette lighter device into the 12-Volt DC outlet. The heated lighter may ignite the fuel causing an explosion or fire.

Power Output and Demand

There are two limits to the amount of electric power that the generator can usefully provide: (a) its total 240-Volt AC or 12-Volt DC electric power generating capacity or power output and (b) the electric current or power output capacity of each individual 240-Volt AC or 12-Volt DC outlet.

The generator's total power output measured in Watts is listed in the *Specifications*. Two 240-Volt AC power outputs are specified for each generator, namely the running power and the starting power. A single 12-Volt DC power output is also specified.

NOTICE

DO NOT overload the generator's 240-Volt AC or 12-Volt DC circuits beyond their rated capacities. This can result in damage to the generator or to the connected devices.

The generator should not be run completely unloaded for extended periods otherwise the engine may be damaged. It is recommended that the generator should always be operated with at least one-third of its rated 240-Volt AC power output.

240-Volt AC devices have two different electric power demands that must be taken into consideration, namely the running power and the starting power. Both are measured in Watts (typically abbreviated as "W").

The steady state continuous load is the running power demand and this is often marked on the device near its model number or serial number. Sometimes the device might only be marked with its voltage (i.e. 240 Volt or 240 V) and current draw (e.g. 6 Ampere or 6 Amp or 6 A), in which case the running power demand in Watts can be obtained by multiplying the voltage times the current, e.g. $240\text{ V} \times 6\text{ A} = 1,440\text{ W}$.

Simple resistive 240-Volt AC devices such as incandescent bulbs, toasters, heaters, etc. have no extra power demand when starting, and so their starting power demands are the same as their running power demands.

More complex 240-Volt AC devices containing inductive or capacitive elements such as electric motors and welders have a momentary extra power demand when starting, which can be up to seven times the running power demand or more. Manufacturers of such devices rarely publish this starting power demand and so it's often necessary to estimate it.

A rule of thumb for devices fitted with an electric motor is to apply a starting power multiplier of 1.2 for small hand-held or portable devices and a value of 3.5 for larger stationary devices. For example, a 900 W angle grinder can be assumed to have a starting power demand of at least $1.2 \times 900 \text{ W}$, which equals 1,080 W. Similarly, a 1,650 W air compressor can be assumed to have a starting power demand of at least $3.5 \times 1,650 \text{ W}$, which equals 5,775 W.

To prevent overloading of the generator's 240-Volt AC system:

1. Add up the running power demand of all the 240-Volt AC devices that will be connected to the generator at one time. This total must not be greater than the generator's specified running power output.
2. Add up the running power demand again, but for the largest motor-driven device use the value of its starting power demand instead of its running power demand. This total must not be greater than the generator's specified starting power output.
3. The total running power demand of all the devices that will be connected to any one of the generator's outlets must not exceed 3,000 W for the WHXC3750 and WHXC3750-PRO models or 3,600 W for the other models.

The above guidelines serve as approximations only of determining the running and starting power demands of 240-Volt AC devices. If in doubt, always err on the conservative side to avoid overloading the generator. In the absence of any power demand information whatsoever, one can assume that any device fitted with a standard domestic 10 A plug has a running power demand of 2,400 W (i.e. $240 \text{ V} \times 10 \text{ A} = 2,400 \text{ W}$). Similarly a device fitted with a heavy duty 15 A plug can be assumed to have a running power demand of 3,600 W (i.e. $240 \text{ V} \times 15 \text{ A} = 3,600 \text{ W}$). And then apply the appropriate multiplying factor for starting power demand if the device has an electric motor.

There are large variations in the performance of different makes and models of electrical devices and the manufacturers specifications are often inaccurate or misleading. It is recommended that the generator and powered device(s) be trialled to ensure that the combination performs satisfactorily.

NOTICE

To prevent overloading of the generator's 12-Volt DC system, do not connect any 12-Volt DC device(s) with a running power demand greater than 100 W.

240-VOLT AC EXTENSION CORDS

Wherever possible, it is recommended to connect 240-Volt AC devices directly to the generator's 240-Volt AC outlet(s). This ensures that the device is supplied with the best quality electricity.

In those instances where it's not practicable or safe to directly plug an electrical device into the generator, the use of an electrical extension cord is necessary.

1. Use only the shortest possible extension cord for the task. Voltage drop increases proportionately with the length of an extension cord and may result in damage to the powered device.
2. Use only a single extension cord and not multiple cords joined together. This will minimise voltage drop and prevent any hazard or inconvenience arising from the joint(s) becoming disconnected.
3. Use only extra heavy duty 15 A extension cords made from 3-core cable of at least 1.5 mm^2 conductor size and fitted with 15 A plugs and sockets (see Figure 27). A 15 A plug cannot be inserted into a standard domestic 10 A socket.
4. Extension cords with conductor size of 1.5 mm^2 or 2.5 mm^2 should not exceed 25 m or 40 m in length, respectively, in accordance with AS/NZS 3199:2007.

NOTICE

DO NOT use standard 10 A extension cords fitted with standard domestic 10 A plugs and sockets. These do not have sufficient current carrying capacity, which will result in excessive voltage drop. 10 A extension cords may overheat and possibly catch fire if overloaded when connected to the generator's 240-Volt 15 A outlets.

NOTICE

DO NOT use extension cords with only 2-pin (active and neutral) plugs and sockets. These extension cords lack the earth connection that is provided by a 3-pin plug and socket joined with a 3-core cable; the vertical pin is the earth connection.

5. The extra heavy duty 240-Volt AC 15 A outlets on the WHXC3750-PRO and WHXC8500E-PRO models can be used with extension cords fitted with Clipsal 56-Series (or equivalent) plugs to achieve a weatherproof IP66 and thread-secured electrical connection.
6. DO NOT use extension cords with any visible signs of damage to the plug, socket or cable.
7. DO NOT use extension cords that are rolled up or knotted as they may overheat.



OPERATION



12 VOLT BATTERY CHARGING

There are two methods by which the generator can be used to charge an external 12 Volt battery:

- A. By direct connection to the generator's 12-Volt DC electrical outlet; or
- B. By using a mains-powered 12 Volt battery charger connected to one of the generator's 240-Volt AC outlets.

Never use either of these methods to charge the generator's own 12 Volt battery.

 **DANGER**

Wet cell batteries produce explosive hydrogen gas while charging. If ignited, the hydrogen gas mixture can explode the battery and cause serious injury or blindness. Only charge a battery in a well-ventilated area away from any sources of ignition such as sparks, open flames, matches, cigarettes, CB radios and mobile phones.

The electrolyte fluid inside a battery contains highly corrosive sulphuric acid, which upon contact with the skin or eyes can cause severe burns or blindness. Always wear protective glasses and clothing – including gloves – when working on a battery. Any electrolyte spill should be thoroughly flushed clean with water.

Battery Charging by Direct Connection

This method is NOT RECOMMENDED and should only be used in an emergency. The generator's 12-Volt DC electrical output is unregulated and may damage the battery due to overcharging.

Tools required (not included) – 12 V DC, 10 A minimum battery charging cable with cigarette lighter plug for connection to the generator and alligator clips (both positive and negative) for connection to the battery.

1. Prepare the battery for charging if it is a user-maintainable type by removing the vent caps and adding demineralised or distilled water until the electrolyte level is just above the internal battery plates. This may not be possible with a maintenance-free battery.
2. Connect the positive (+) alligator clip (red) to the positive (+) terminal on the battery.
3. Connect the negative (-) alligator clip (black) to the negative (-) terminal on the battery.
4. Start the generator.

5. Insert the cigarette lighter plug into the generator's 12-Volt DC accessory socket. The battery is now charging. Keep the battery as far away as possible from the generator due to the explosive gas hazard.
6. Monitor the generator's 12-Volt DC circuit breaker. If it switches itself off due to overload as indicated by the push button extending out from the control panel, reset it manually by pushing it back in. If it continues to switch itself off, the current demand is too high and the battery cannot be charged by this method.
7. Monitor the battery; stop charging if the battery gets hot to the touch and the electrolyte boils violently.
8. Variables such as battery size and initial state of charge make it impossible to definitively recommend the charging period. Some batteries have a state of charge indicator that can be visually checked. Otherwise a voltmeter or hydrometer is necessary to accurately determine the battery's condition. A fully charged battery will have an open circuit voltage of at least 12.6 V and an electrolyte specific gravity of at least 1.265. In the absence of any state of charge tools, stop the charging after, say, 3 hours and check whether the battery is capable of powering the required application, e.g. to start a car's engine.
9. Remove the cigarette lighter plug from the generator's 12-Volt DC accessory socket.
10. Stop the generator unless it's being used to power some other 240-Volt AC device(s).
11. Disconnect the negative (-) alligator clip (black) from the negative (-) terminal on the battery.
12. Disconnect the positive (+) alligator clip (red) from the positive (+) terminal on the battery.
13. Re-fit the battery's vent caps, if applicable. The battery can now be used.

Battery Charging by a Mains-Powered Charger

This method is RECOMMENDED. Using a proper mains-powered 12 Volt battery charger will ensure that the battery is optimally charged and without risk of damage due to overcharging.

Tools required (not included) – 240-Volt AC powered 12 V DC battery charger.

1. Prepare the battery for charging if it is a user-maintainable type by removing the vent caps and adding demineralised or distilled water until the electrolyte level is just above the internal battery plates. This may not be possible with a maintenance-free battery.

2. Connect the battery charger's positive (+) alligator clip or terminal clamp (red) to the positive (+) terminal on the battery.
3. Connect the battery charger's negative (-) alligator clip or terminal clamp (black) to the negative (-) terminal on the battery.
4. Start the generator.
5. Make any necessary pre-charging adjustments or settings on the battery charger in accordance with its operating instructions.
6. Insert the battery charger's power supply plug into one of the generator's 240-Volt AC outlet sockets. Switch the generator's 240-Volt AC circuit breaker to the **ON** position and then switch the battery charger **ON**. The battery is now charging. Keep the battery as far away as possible from the generator due to the explosive gas hazard.
7. Monitor the battery; stop charging if the battery gets hot to the touch and the electrolyte boils violently.
8. Monitor the battery charger in accordance with its operating instructions and switch it off when indicated to do so.
9. Switch the battery charger **OFF** and unplug its power supply cord from the generator.
10. Stop the generator unless it's being used to power some other 240-Volt AC device(s).
11. Disconnect the battery charger's negative (-) alligator clip or terminal clamp (black) from the negative (-) terminal on the battery.
12. Disconnect the battery charger's positive (+) alligator clip or terminal clamp (red) from the positive (+) terminal on the battery.
13. Re-fit the battery's vent caps, if applicable. The battery is now charged and ready for use.

TRANSPORTING THE GENERATOR

The generator should be stopped and the fuel shutoff valve should be turned to the **OFF** position before transporting the generator. Keep the unit level during transport to minimise the possibility of fuel leakage or, if practicable, drain out the fuel prior to transport as described in *Draining the Fuel*.

If the generator has been operating, allow the unit to cool down before loading it onto the transport vehicle.

The generator's wheels are only intended for ease of moving the generator around by hand. The wheels are not suitable for towing the generator either on or off-road.





Use only the generator's frame for lifting the unit or attaching any load restraints such as ropes or tie-down straps as shown in *Figure 29*. Do not attempt to lift or secure the generator by holding onto any of its other components.





Figure 29 – Generator Restraint for Transport



MAINTENANCE

MAINTENANCE PRECAUTIONS

 WARNING	
	Avoid accidentally starting the generator during maintenance by removing the spark plug boot from the spark plug. For electric start generators, also disconnect the battery cables from the battery (disconnect the black negative (-) cable first) and place the wires away from the terminals to avoid arcing.
	Allow hot components to cool to the touch prior to performing any maintenance procedure.
	Internal pressure can build in the engine crankcase while the engine is running. Removing the oil fill plug/dipstick while the engine is hot can cause extremely hot oil to spray out of the crankcase and severely burn skin. Allow engine oil to cool for several minutes before removing the oil fill plug/dipstick.
	Always perform maintenance in a well-ventilated area. Fuel and fuel vapours are extremely flammable and can ignite under certain conditions.

 CAUTION	
	Avoid skin contact with engine oil or fuel. Prolonged skin contact with engine oil or fuel can be harmful. Frequent and prolonged contact with engine oil may cause skin cancer. Take protective measures and wear protective clothing and equipment. Wash all exposed skin with soap and water.

Maintenance Schedule

 WARNING	
	Failure to perform periodic maintenance or not following maintenance procedures can cause the generator to malfunction and could result in death or serious injury.

NOTICE	
Periodic maintenance intervals vary depending on generator operating conditions. Operating the generator under severe conditions, such as sustained high-load, high-temperature, or unusually wet or dusty environments, will require more frequent periodic maintenance. The intervals listed in the maintenance schedule should be treated only as a general minimum guideline. Use only genuine Westinghouse spare parts or others as specified herein. Non-genuine spare parts may be of inferior quality and cause damage to the generator.	

Following the maintenance schedule is essential to keep the generator in good operating condition. *Table 1* provides a summary of routine inspection procedures and simple maintenance tasks that can be performed by someone with mechanical competence using commonly available hand tools. Alternatively, an authorised Westinghouse service dealer can carry out this work for a fee.

Table 1: Basic Maintenance Schedule - Owner Performed

Maintenance Item	Before Every Use	After First 20 Hours or First Month *	After 50 Hours or Every 3 Months *	After 100 Hours or Every 6 Months *	After 300 Hours or Every Year *
Engine Oil	Check / Add	Change	–	Change	–
Air Filter	Check / Clean	–	Clean ^	–	Replace
Spark Plug	–	–	–	Check / Clean	Replace
Fuel Strainer	–	–	–	Clean	–
Fuel Sediment Cup	–	–	–	Clean	–
Spark Arrester	–	–	–	Clean	–
Exterior Surfaces	Check / Clean	–	–	–	–
RCD Safety Switch ⁺	Test	–	–	–	–

* Whichever occurs first. ⁺ If so equipped. [^] Service more frequently if operating in dusty conditions.

Table 2 lists the more complicated maintenance tasks that are best performed by a qualified mechanic using specialised tools. It is recommended to engage an authorised Westinghouse service dealer to carry out this work.

Table 2: Advanced Maintenance Schedule - Authorised Westinghouse Service Dealer Performed

Maintenance Item	Before Every Use	After First 20 Hours or First Month *	After 50 Hours or Every 3 Months *	After 100 Hours or Every 6 Months *	After 300 Hours or Every Year *
Valve Clearance	-	-	-	-	Check / Adjust
Idle Speed	-	-	-	-	Check / Adjust

* Whichever occurs first.

ENGINE OIL MAINTENANCE

Engine Oil Specification

Use premium quality 4-stroke engine oil with an API Service Classification of at least SG. A SAE multigrade viscosity of 5W-30 or 10W-30 is suitable for use in ambient temperatures of up to 40°C. For temperatures above 40°C, a multigrade viscosity of 10W-40 or 15W-40 is recommended.

NEVER use 2-stroke engine oil either directly in the engine or mixed with the fuel.

Mineral based, semi-synthetic or fully synthetic oils may be used, but different types of oils should not be mixed together. The engine oil supplied originally with the generator is a mineral type with SAE 10W-30 viscosity.

Checking Engine Oil

NOTICE

Always maintain proper engine oil level. Failure to maintain proper engine oil level can result in severe damage to the engine or shorten the life of the engine.

Always use the specified engine oil. Failure to use the specified engine oil can cause accelerated wear or shorten the life of the engine.

Engine oil level should be checked before every use.

1. Always operate or maintain the generator on a flat surface.
2. Stop engine if running.
3. Let engine sit and cool for several minutes (allow crankcase pressure to equalise).
4. With a damp rag, clean around the oil fill plug/dipstick.
5. Remove oil fill plug/dipstick by unscrewing it anti-clockwise (see Figure 30).
6. Check oil level:

When checking the engine oil, remove the oil fill plug/dipstick and wipe it clean. Then re-insert the oil fill plug/dipstick without screwing it into the oil filler neck, remove it and check the oil level indicated.

- Acceptable Oil Level – Oil is visible on the crosshatches between the H and L lines on the oil fill plug/dipstick (see Figure 31).
- Low Oil Level – Oil is below the L line on the oil fill plug/dipstick.

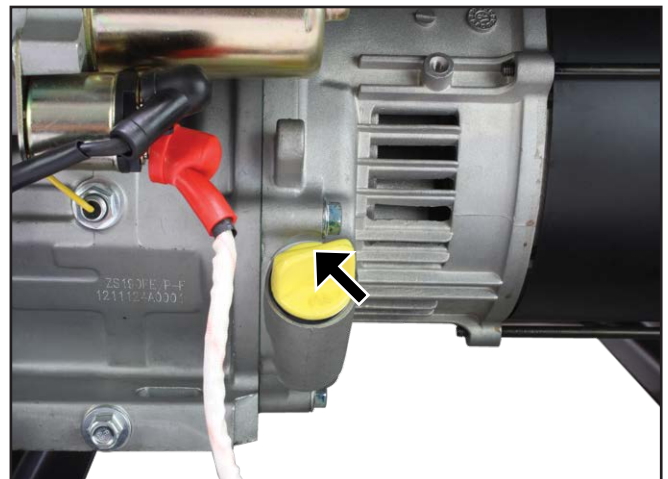

Figure 30 – Oil Fill Plug/Dipstick

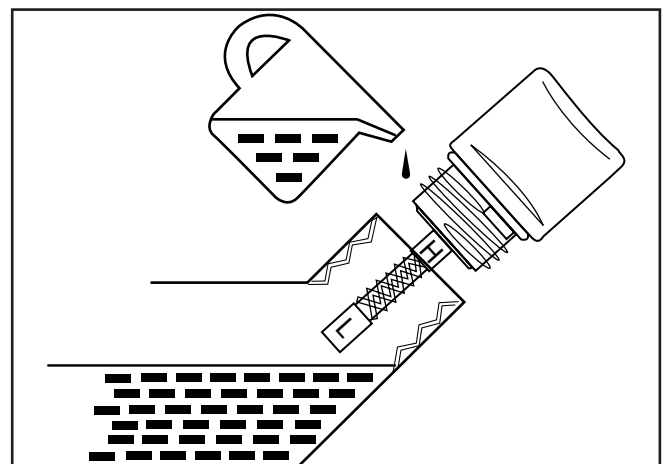

Figure 31 – Checking Oil Level



MAINTENANCE

Adding Engine Oil

1. Always operate or maintain the generator on a flat surface.
2. Stop engine if running.
3. Let engine sit and cool for several minutes (allow crankcase pressure to equalise).
4. Thoroughly clean around the oil fill plug/dipstick.
5. Remove oil fill plug/dipstick and wipe clean.
6. Select the proper engine oil as explained in *Engine Oil Specification*.
7. Using the supplied funnel and tube, slowly add engine oil to the engine as shown in *Figure 32*. Stop frequently to check the level to avoid overfilling.



Figure 32 – Adding Engine Oil

8. Continue to add oil until the oil is at the correct level. See *Checking Engine Oil*. A simple visual guide is to observe the oil level relative to the bottom lip of the oil filler neck in the engine (into which the oil plug/dipstick is screwed). If the oil reaches the bottom lip, then it's at the high level. If the oil is above the bottom lip and flows out of the hole, then it's too full and the excess must be drained out.

Changing Engine Oil

Tools required (not included) – 10 mm spanner (for models WHXC3750 and WHXC3750-PRO) or 12 mm spanner (for all other models) and oil drain pan.

1. Stop the engine.
2. Let engine sit and cool for several minutes (allow crankcase pressure to equalise).
3. Place oil pan (or suitable container) under the oil drain plug.
4. With a damp rag, thoroughly clean around the oil drain plug.

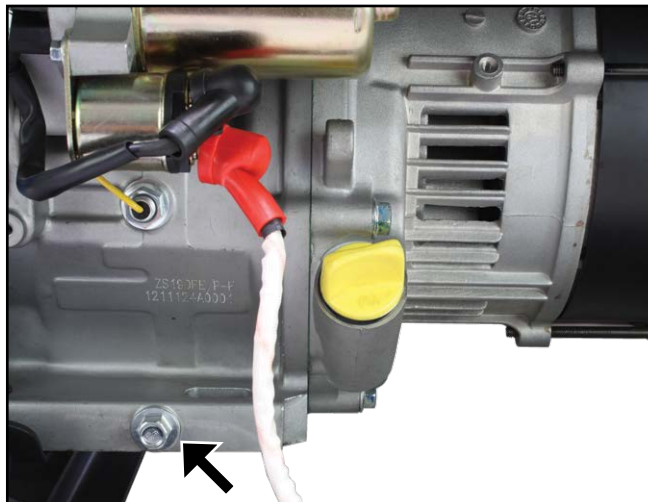

Figure 33 – Oil Drain Plug

5. Remove the oil drain plug (see *Figure 33*). Once removed, place the oil drain plug on a clean surface.
6. Remove the oil fill plug/dipstick so the oil can flow more easily from the oil drain port.
7. Allow oil to drain completely.
8. Replace and tighten oil drain plug.
9. Fill crankcase with oil following the steps outlined in *Adding Engine Oil*.
10. Dispose of used engine oil properly.

NOTICE

Never dispose of used engine oil by dumping the oil into a sewer, on the ground, or into groundwater or waterways. Always be environmentally responsible. Follow the guidelines of the governmental agencies for proper disposal of hazardous materials. Consult local authorities or reclamation facility.

AIR FILTER MAINTENANCE

WARNING



Never use fuel or other flammable solvents to clean the air filter. Use only household detergent and warm water or alternatively a non-flammable solvent.

NOTICE

Do not operate the generator without an air filter element or with a damaged air filter element. This will allow dirt to enter the engine and cause accelerated wear or shorten the life of the engine.

Cleaning the Air Filter (Models WHXC3750 & WHXC3750-PRO)

The air filter must be cleaned after every 50 hours of use or 3 months (frequency should be increased if generator is operated in a dusty environment).

1. Turn off the generator and let it cool for several minutes if it's been running.
2. Move the generator to a flat, level surface.
3. Unscrew the knob at the bottom of the air filter assembly (see Figure 34) anti-clockwise until the air filter cover can move outwards freely.
4. Slowly lift up and disengage the top tabs of the air filter cover (see Figure 34). Clean the air filter cover with a rag and place it aside.



Figure 34 – Removing Air Filter Cover

5. Remove the foam air filter element while taking care to note the position of the notch (see Figure 35). The air filter element must be re-installed later with this notch in the same position.

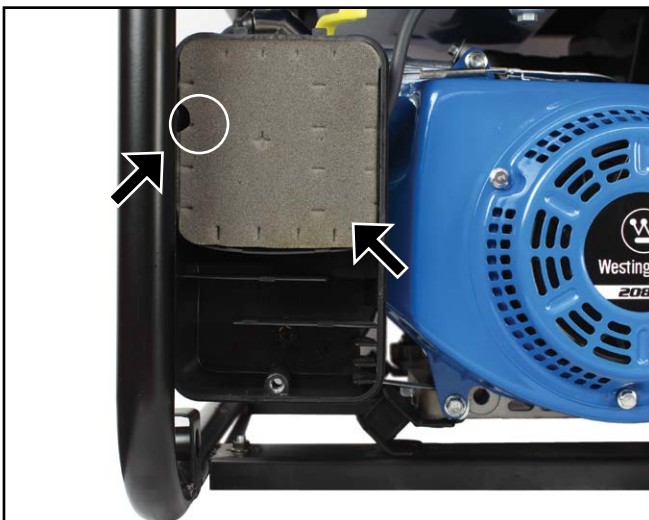

Figure 35 – Removing Air Filter Element

6. Pay special attention also to the metal backfire plate in the upper left corner of the air filter assembly box. This metal plate must be in its proper position when re-installing the air filter element (see Figure 36).

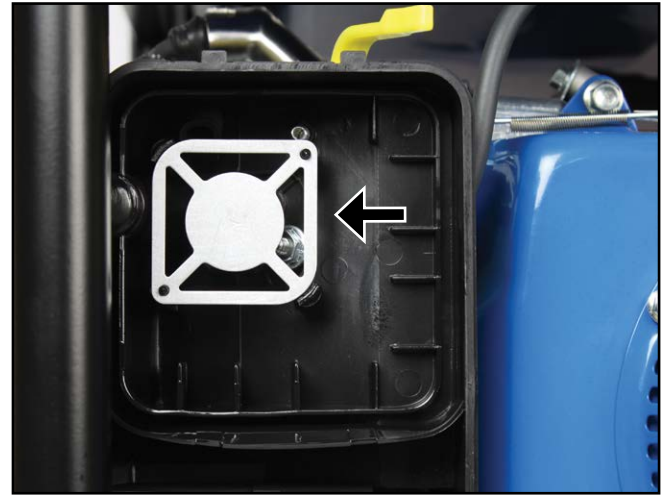

Figure 36 – Position of Metal Backfire Plate

7. Wash the air filter element in a solution of household detergent and warm water or alternatively in non-flammable solvent. Slowly squeeze the foam in the liquid for a thorough cleaning action. Then remove the foam and squeeze out the liquid.

NOTICE

NEVER twist or tear the air filter element during cleaning or drying. Apply only a slow and firm squeezing action.

8. Rinse the air filter element by immersing it in fresh water and applying a slow squeezing action.

NOTICE

Never dispose of the used cleaning solution or solvent by dumping it into a sewer, on the ground, into groundwater or into a waterway. Always be environmentally responsible. Follow the guidelines of the governmental agencies for proper disposal of hazardous materials. Consult local authorities or reclamation facility.

9. Dry the air filter element by repeatedly applying a slow firm squeezing action.
10. Coat the air filter element in clean engine oil and then thoroughly squeeze out the excess liquid.
11. Re-install the air filter element inside the air filter assembly box. Make sure the metal backfire plate is in its proper position (see Figure 36) and the notch in the foam is correctly located (see Figure 35).



MAINTENANCE

12. Install the air filter cover by re-engaging the tabs on the top of the air filter assembly and then tightening the knob clockwise (see Figure 37).



Figure 37 – Installation of Air Filter Cover

Cleaning the Air Filter (Models WHXC5000, WHXC7000, WHXC8500E, WHXC8500E-PRO & WHXC8500E-AS)

The air filter must be cleaned after every 50 hours of use or 3 months (frequency should be increased if generator is operated in a dusty environment).

1. Turn off the generator and let it cool for several minutes if it's been running.
2. Move the generator to a flat, level surface.
3. Release the latches at the top and bottom of the air filter assembly (see Figure 38).

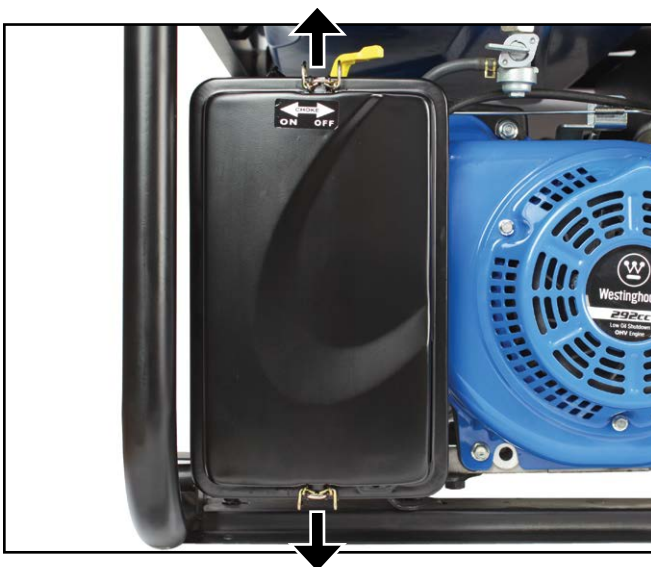

Figure 38 – Removing Air Filter Cover

4. Pull the air filter cover off and away from the air filter assembly noting its orientation with the choke function decal at the top. Clean the air filter cover with a rag and place it aside.

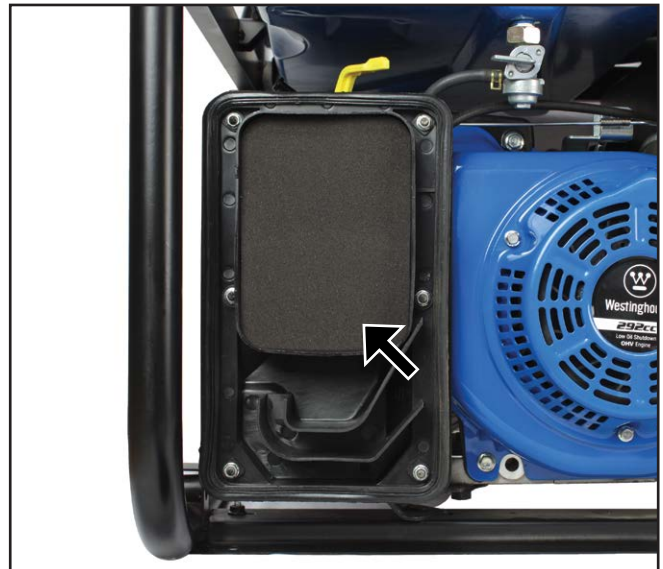

Figure 39 – Removing Air Filter Elements

5. Remove the two foam air filter elements while taking care to note their positions (see Figures 39 and 40). The black foam air filter element is the coarse stage and must be re-installed at the front directly underneath the air filter cover. The grey foam air filter element is the fine stage and must be re-installed at the back of the air filter assembly.



Figure 40 – Fine (Left, Grey) and Coarse (Right, Black) Air Filter Elements

6. Wash the air filter elements in a solution of household detergent and warm water or alternatively in non-flammable solvent. Slowly squeeze each foam element separately in the liquid for a thorough cleaning action. Then remove each foam and squeeze out the liquid.

NOTICE

NEVER twist or tear the air filter elements during cleaning or drying. Apply only a slow and firm squeezing action.

7. Rinse the air filter elements by immersing each one separately in fresh water and applying a slow squeezing action.

NOTICE

Never dispose of the used cleaning solution or solvent by dumping it into a sewer, on the ground, into groundwater or into a waterway. Always be environmentally responsible. Follow the guidelines of the governmental agencies for proper disposal of hazardous materials. Consult local authorities or reclamation facility.

8. Dry each of the air filter elements by repeatedly applying a slow firm squeezing action.
9. Coat the air filter elements separately in clean engine oil and then thoroughly squeeze out the excess liquid.
10. Re-install the air filter elements inside the air filter assembly box. Make sure the air filter elements are correctly positioned with the grey foam at the back and the black foam at the front closest to the air filter cover (see Figures 39 and 40).
11. Replace the air filter cover correctly orientated with the choke function decal at the top and then fasten the top and bottom latches (see Figure 41).

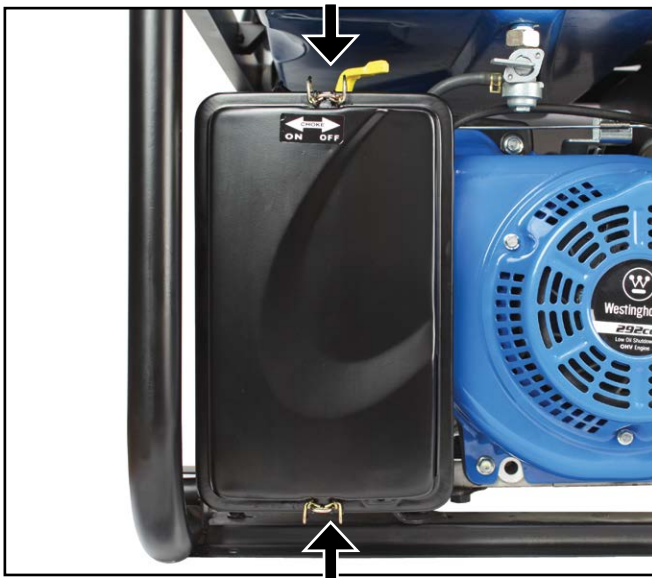

Figure 41 – Installation of Air Filter Cover

FUEL STRAINER MAINTENANCE

Check and clean the fuel strainer after every 100 hours of use or 6 months. It is recommended that this maintenance task be performed each time when filling with fuel from any source other than directly from a service station bowser.

1. Shut off the generator if it's been running.
2. Allow the generator to cool down so all surface areas of the muffler and engine are cool to the touch.
3. Remove the generator to a flat surface.
4. Clean area around the fuel cap.
5. Remove the fuel cap by unscrewing it anti-clockwise and set it aside on a clean surface.
6. Remove the fuel strainer by hand from inside the filling hole on top of the fuel tank (see Figure 42) taking care not to tear or otherwise damage the fine mesh screen. Keep the fuel strainer vertical so that any trapped liquid or solids do not spill onto the generator.



Figure 42 – Removing Fuel Strainer.

7. Pour the contents of the fuel strainer into a suitable waste receptacle. Low pressure compressed air can be used if necessary by blowing onto the outside of the strainer mesh to remove any trapped fine grit.

NOTICE

Never dispose of fuel or fuel contaminants by dumping either of them into a sewer, on the ground, or into groundwater or waterways. Always be environmentally responsible. Follow the guidelines of the governmental agencies for proper disposal of hazardous materials. Consult local authorities or reclamation facility.



MAINTENANCE

8. Re-install the fuel strainer by hand inside the filling hole on top of the fuel tank (see Figure 43). Make sure it is fully inserted into the opening and properly seated on the underside of its top rim.



Figure 43 – Re-installing Fuel Strainer

9. Re-install the fuel cap on the fuel tank by screwing it in clockwise until a clicking sound is heard.

FUEL SEDIMENT CUP MAINTENANCE

Tools required (not included) – 10 mm spanner.

1. Shut off the generator if it's been running.
2. Allow the generator to cool down so all surface areas of the muffler and engine are cool to the touch.
3. Move the generator to a flat surface.
4. Turn the fuel shutoff valve to the **OFF** position.
5. Clean the exterior of the fuel shutoff valve and sediment cup with a rag.
6. Unscrew the sediment cup anti-clockwise (see Figure 44) taking care to hold it with one hand to prevent it from dropping onto the ground and spilling its contents. Remove also the O-ring and sediment filter (see Figure 45) by hand.
7. Pour the contents of the fuel sediment cup into a suitable waste receptacle and then use a rag to wipe it clean and dry.
8. Tap the fuel sediment filter lightly or use low pressure compressed air if necessary to remove any fine grit trapped in the filter mesh.

NOTICE

Never dispose of fuel or fuel contaminants by dumping either of them into a sewer, on the ground, or into groundwater or waterways. Always be environmentally responsible. Follow the guidelines of the governmental agencies for proper disposal of hazardous materials. Consult local authorities or reclamation facility.

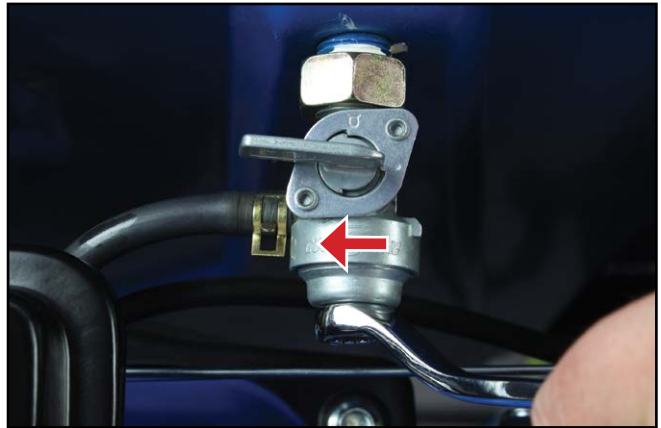

Figure 44 – Removing Fuel Sediment Cup



Figure 45 – Fuel Sediment Cup, O-ring and Filter

9. Re-install the fuel sediment filter by hand taking care to ensure the round hole in the filter aligns with the inlet port inside the fuel shutoff valve (see Figure 46).



Figure 46 – Re-installing Fuel Sediment Cup Filter

10. Re-install the O-ring and fuel sediment cup by hand taking care to ensure the O-ring is properly seated around its perimeter up against the inside of the fuel shutoff valve. Finish tightening the fuel sediment cup by screwing it clockwise with a spanner.

- Turn the fuel shutoff valve to the **ON** position and check for any leaks around the threaded joint where the fuel sediment cup screws into the fuel shutoff valve. Tightening the fuel sediment cup a bit more with a spanner should seal off any normal leak. If this doesn't work, repeat steps 4 to 10 above taking particular care with installation of the fuel sediment filter and O-ring.
- After confirming there are no fuel leaks, turn the fuel shutoff valve to the **OFF** position.

SPARK PLUG MAINTENANCE

Tools required – Spark plug socket wrench (included), spark plug gap tool or feeler gauge (not included) and wire brush (not included).

The spark plug must be checked and cleaned after every 100 hours of use or 6 months and must be replaced after 300 hours of use or every year.

- Stop the generator and let it cool for several minutes if it's been running.
- Move the generator to a flat, level surface.
- Remove the spark plug boot by firmly pulling it directly away from the engine (see *Figure 47*).

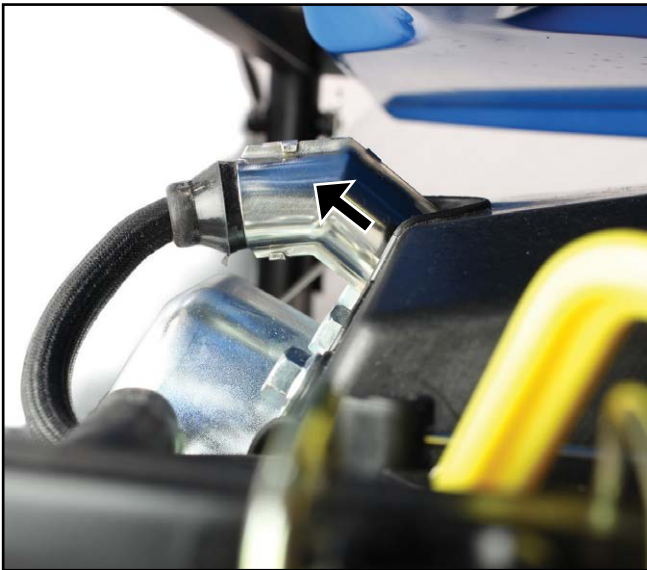

Figure 47 – Removal of Spark Plug Boot

NOTICE

Never apply any side load or move the spark plug laterally when removing the spark plug. Applying a side load or moving the spark plug laterally may crack and damage the spark plug insulator.

- Clean area around the spark plug.
- Use a spark plug socket wrench to remove the spark plug from the cylinder head by unscrewing it anti-clockwise (see *Figure 48*).



Figure 48 – Removing Spark Plug

- Place a clean rag over the opening created by the removal of the spark plug to make sure no dirt can get into the combustion chamber.
- Inspect the spark plug for:
 - Cracked or chipped insulator; replace the spark plug.
 - Excessive wear of the electrodes; replace the spark plug.
 - Excessive carbon or oil fouling of the electrodes; clean the electrodes with a wire brush or replace the spark plug.
 - Spark plug gap within the acceptable limits of 0.70 – 0.80 mm or 0.028 – 0.031 inch (see *Figure 49*); after cleaning with a wire brush, check using a spark plug gap tool or feeler gauge and adjust by carefully bending the ground electrode. Always check the gap of a new spark plug before installing it.

When replacing the spark plug, use only a Torch F6RTC or equivalent spark plug such as Bosch WR7DC+, Denso W20EPR-U, NGK BPR6ES or Champion RN9YC.

NOTICE

Use only the recommended spark plug (Torch F6RTC or equivalent). The use of a non-recommended spark plug can result in damage to the engine.



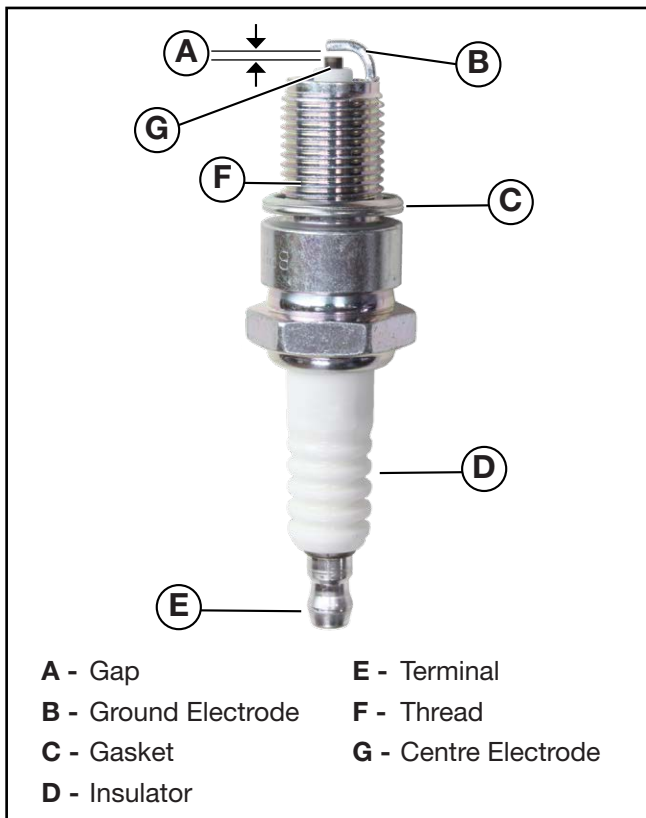

Figure 49 – Spark Plug

8. Install the spark plug by carefully following the steps outlined below:
 - a - Carefully insert the spark plug back into the cylinder head. Hand screw the spark plug clockwise until it bottoms out (seats).
 - b - Use a spark plug socket wrench to finish tightening the spark plug. If re-installing a used spark plug, tighten 1/8 to 1/4 of a turn after the spark plug seats. If installing a new spark plug, tighten 1/2 turn after the spark plug seats.
 - c - Replace the spark plug boot, making sure the boot fully engages onto the spark plug's terminal.

SPARK ARRESTER MAINTENANCE

Tools required (not included) – 5 mm flat head screwdriver, wire brush.

Check and clean the spark arrester after every 100 hours of use or 6 months.

1. Stop the generator and let it cool for several minutes if it's been running.
2. Move the generator to a flat, level surface.
3. Using a flat head screwdriver, loosen the spark arrester band clamp by turning the adjusting screw anti-clockwise (see Figure 50).

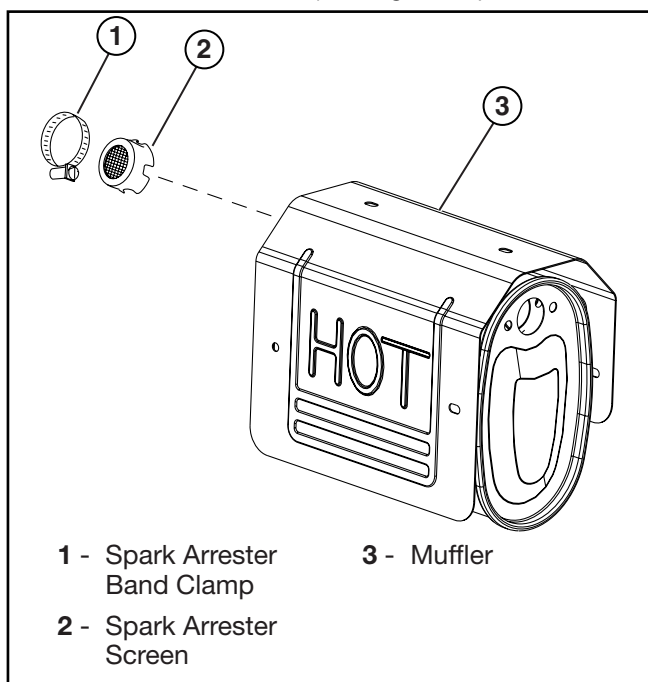

Figure 50 – Spark Arrester Assembly

4. Slide the spark arrester band clamp off the spark arrester screen.
5. Pull the spark arrester screen off the muffler exhaust pipe.
6. Using a wire brush, remove any dirt and debris that may have collected on the spark arrester screen.
7. If the spark arrester screen shows signs of wear such as rips, tears or large openings, it must be replaced.
8. Re-install the spark arrester components in the following order:
 - a - Place spark arrester screen over the muffler exhaust pipe. Push on the screen until it fully bottoms out.
 - b - Place the spark arrester band clamp over the screen and tighten the adjusting screw clockwise with a flat head screwdriver.



CLEANING THE GENERATOR

The generator should be kept clean and dry at all times to ensure its reliable and safe operation. This must be checked each time before using the generator.

Use a damp cloth which has been soaked in a mixture of household detergent and warm water and then wrung out to remove excess liquid. Wipe the exterior surfaces of the generator clean and then repeat with a damp cloth which has been rinsed in clean water and wrung out. Finish by wiping off all moisture with a dry cloth. Do not use abrasive or solvent cleaners.

A soft, non-metallic bristle brush or a vacuum cleaner may be used to loosen and remove any built-up dirt, mud or other debris. Low pressure compressed air may also be used to blow off any dirt or dust.

NOTICE

NEVER use a water hose or pressure washer to clean the generator. Water may enter the fuel or electric systems and damage the generator. The risk of electric shock is also possible.



Figure 51 – Engine Cooling Air Inlet Ports

Make sure all of the engine and alternator cooling air ports are clean of any dirt or other debris (see Figures 51, 52 and 53) otherwise the generator may overheat and be damaged.

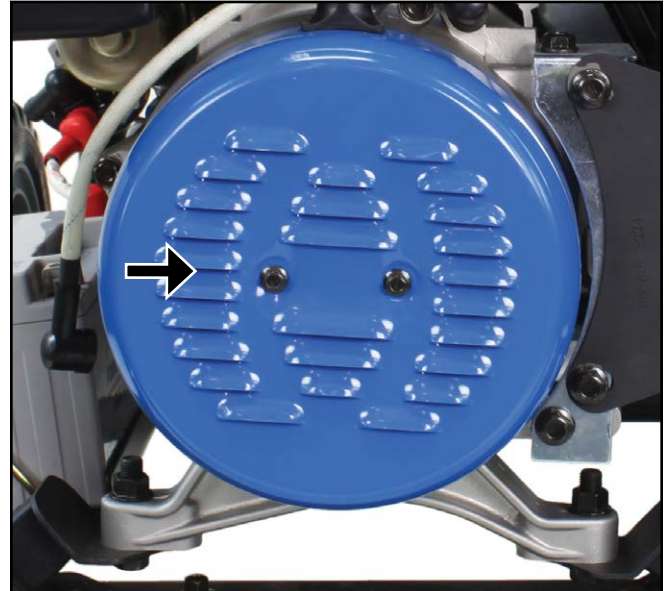

Figure 52 – Alternator Cooling Air Inlet Ports



Figure 53 – Alternator Cooling Air Inlet and Outlet Ports



MAINTENANCE

RCD SAFETY SWITCH TESTING (IF SO EQUIPPED)

1. Start the generator as described in *Starting the Generator*, but do not connect any electrical cords or devices into the 240-Volt AC or 12-Volt DC outlets.
2. Turn the locking screw on the RCD safety switch cover anti-clockwise by hand (see *Figure 54*) until the cover is released.

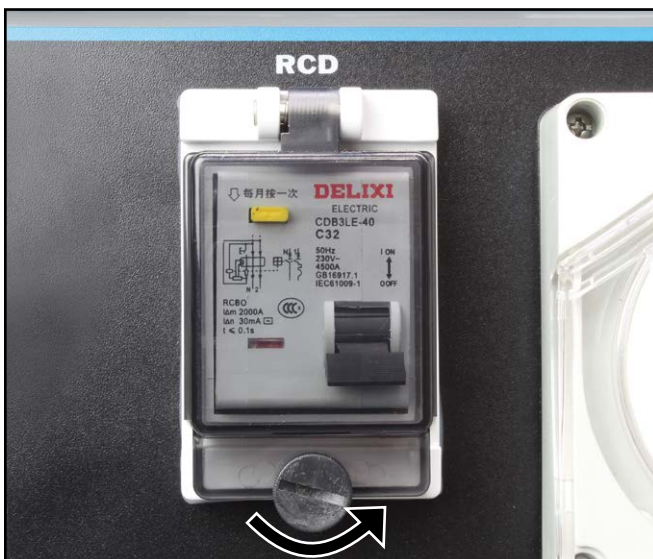

Figure 54 – Opening the RCD Safety Switch Cover

3. Pull forward on the bottom of the RCD safety switch cover and pivot it upwards to open.
4. Check the RCD safety switch circuit breaker is in the upwards **ON** position (see *Figure 55*).

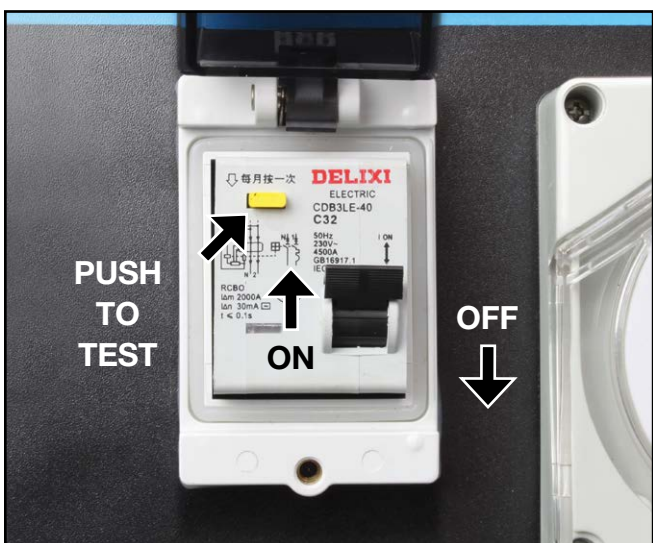

Figure 55 – RCD Safety Switch Controls

5. Push the yellow **TEST** button momentarily. The RCD safety switch circuit breaker should instantly flick downwards to the **OFF** position; this indicates that the RCD safety switch is functioning correctly.

⚠ WARNING



If the RCD safety switch fails the **TEST** function, either by the circuit breaker not moving to the **OFF** position at all or by doing so in a slow or delayed manner, the generator should not be used. Stop the generator as described in *Stopping the Generator* and take it to your nearest authorised Westinghouse service dealer.

6. If the RCD safety switch passes the **TEST** function, push the circuit breaker switch back upwards to the **ON** position. Close the cover and secure it in place by turning the locking screw clockwise by hand. The generator is now ready for use.

12 VOLT BATTERY MAINTENANCE (IF SO EQUIPPED)

The generator's 12 Volt battery (if so equipped) is a sealed-for-life type that requires no regular maintenance. It is automatically charged whenever the generator is running.

The battery will self-discharge slowly when not in use and after some time it may have insufficient charge to start the generator; in such an event, the generator can be started manually (see *Manually Starting a Generator*) or the battery can be charged or replaced to enable starting the generator electrically.

When left in auto-start standby mode, the WHXC8500E-AS model will discharge its battery slightly faster due to the small power consumption (i.e. less than 1 Watt) of the auto start active indicator light for safety. To ensure that an electric start generator is ready to operate at any time, a maintenance charger can be connected to its 12 Volt battery to keep it fully charged.

DANGER



Wet cell batteries produce explosive hydrogen gas while charging. If ignited, the hydrogen gas mixture can explode the battery and cause serious injury or blindness. Only charge a battery in a well-ventilated area away from any sources of ignition such as sparks, open flames, matches, cigarettes, CB radios and mobile phones.



The electrolyte fluid inside a battery contains highly corrosive sulphuric acid, which upon contact with the skin or eyes can cause severe burns or blindness. Always wear protective glasses and clothing – including gloves – when working on a battery. Any electrolyte spill should be thoroughly flushed clean with water.

Battery Bulk Charging

If the battery has become so discharged that it is unable to start the generator, it can be restored using a conventional mains-powered 12 Volt battery charger.

Tools required (not included) – 10 mm spanner and mains-powered 12 Volt battery charger.

1. Ensure the generator is stopped and the engine control switch is in the **STOP** position.
2. Allow the generator to cool down if it has been running.

WARNING



NEVER touch both battery terminals simultaneously.
NEVER place a tool or other metal object across both battery terminals.
NEVER place a tool or other metal object between either of the battery terminals and any part of the generator.

3. Disconnect the negative (-) battery cable (black boot) from the negative (-) terminal on the battery.
4. Disconnect the positive (+) battery cable (red boot) from the positive (+) terminal on the battery.
5. Unscrew the nuts from the battery clamp by turning them anti-clockwise with the spanner and then remove the clamp (see *Figure 8*).
6. Remove the battery from the generator taking care not to touch the battery terminals against the generator's frame or any other metal surface. Keep the battery upright at all times.

7. Move the battery to a well-ventilated work bench or other suitable location adjacent to the battery charger.
8. Charge the battery in accordance with the battery charger's instructions.
9. When the battery has finished charging, disconnect it from the battery charger and then re-install it on the generator.
10. Re-fit the battery clamp and then tighten the nuts evenly by screwing them clockwise with the spanner.
11. Connect the positive (+) battery cable (red boot) to the positive (+) terminal on the battery.
12. Connect the negative (-) battery cable (black boot) to the negative (-) terminal on the battery.

Battery Maintenance Charging

The generator's 12 Volt battery can be preserved in a fully-charged state in-situ by keeping it connected to a suitable battery maintenance charger.

It is recommended to use only a premium quality "smart" microprocessor-controlled maintenance charger from a reputable manufacturer to ensure that the battery is not damaged due to overcharging. Such maintenance chargers can be either mains-powered or solar-powered.

Do not use a fixed current trickle charger nor a solar panel without an intelligent 12 Volt maintenance charge controller / regulator. Such devices will overcharge and damage the battery.

Follow the instructions provided with the battery charger. If the generator will never be operated with the battery maintenance charger connected, then it is safe to use the charger's standard output cable alligator clips to connect to the battery terminals. If the charger is to be left connected to the generator at all times, for example whilst using a WHXC8500E-AS model in auto-start standby mode with the 2-wire remote control active, then the charger's output cables should be hardwired to the battery terminals.

Replacing the Battery

The procedure for replacing the generator's 12 Volt battery with a new one is essentially the same as that described in Battery Bulk Charging, except a new battery should be re-installed at step 9 instead of the old one.



MAINTENANCE

DRAINING THE FUEL

Occasionally it may be necessary to drain all of the fuel out of the generator. For example, to remove contaminated or stale fuel or to prepare the generator for transport or storage.

Tools required (not included) – 10 mm spanner, funnel and fuel storage container.

1. Turn the fuel shutoff valve to the **ON** position (see Figure 16).
2. Clean the fuel strainer (see *Fuel Strainer Maintenance*).
3. Position the funnel and fuel storage container under the carburettor drain screw and then remove the screw by turning it anti-clockwise with the spanner (see Figure 56 or 57, as appropriate).

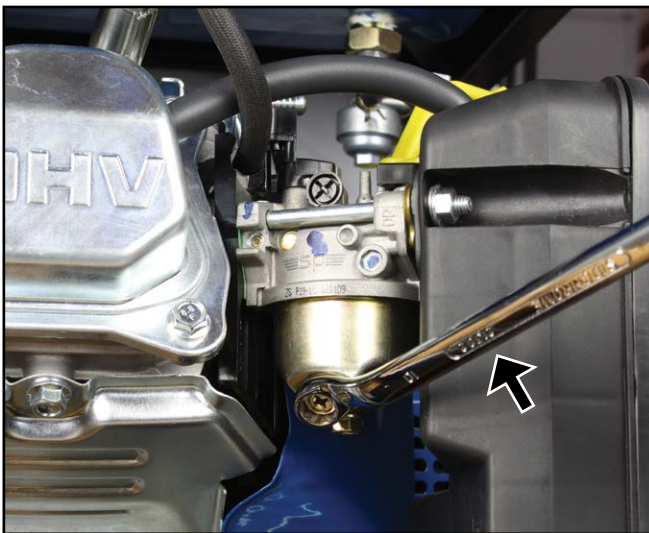

Figure 56 – Removing the Carburettor Drain Screw (WHXC3750 & WHXC3750-PRO)

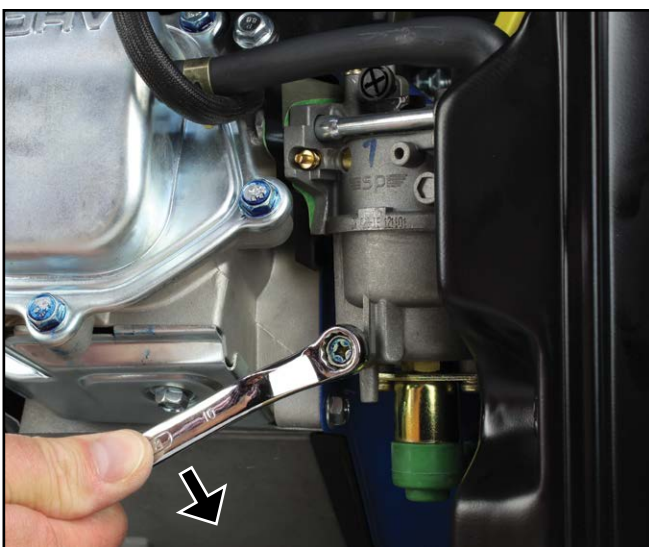

Figure 57 – Removing the Carburettor Drain Screw (WHXC5000, WHXC7000, WHXC8500E, WHXC8500E-PRO & WHXC8500E-AS)

4. Carefully drain the fuel into the storage container. Take care to wipe up any spills immediately.
5. When all of the fuel has been drained out, re-install the carburettor drain screw by turning it clockwise by hand first, and then finish tightening it with the spanner. Move the funnel, storage container and any fuel soaked rags away from the generator. It is preferable to consume the fuel in another engine-powered device straight away or dispose of it properly rather than storing it for a long time with fuel stabiliser for later re-use.
6. Turn the fuel shutoff valve to the **OFF** position and then clean the fuel sediment cup (see *Fuel Sediment Cup Maintenance*).

NOTICE

Never dispose of fuel or fuel contaminants by dumping either of them into a sewer, on the ground, or into groundwater or waterways. Always be environmentally responsible. Follow the guidelines of the governmental agencies for proper disposal of hazardous materials. Consult local authorities or reclamation facility.

LONG-TERM STORAGE

WARNING



Never store a generator with fuel in the tank indoors or in a poorly ventilated area where the fumes can come in contact with an ignition source such as: a pilot light of a stove, water heater, clothes dryer or any other gas appliance; or a spark from an electric appliance.

NOTICE

Fuel stored for as little as 30 days can go bad, causing gum, varnish and corrosive build-up in fuel lines, fuel passages and the engine. This corrosive build-up restricts the flow of fuel, preventing an engine from starting after a prolonged period of storage.

The most commonly experienced faults with portable generators are directly attributable to stale fuel. Such faults are not covered by the generator's warranty.

The generator should be run at least once per month for 30 minutes under no less than one-third of full load. If this is not possible, the generator should be prepared for long-term storage as described hereunder.

Proper care should be taken to prepare the generator for any long-term storage. This will protect the generator's function and appearance, and will make it easier to start when required on the next occasion.

Storage Procedure for 1 – 3 Months

1. Clean the generator as outlined in *Cleaning the Generator*.
2. Add a proprietary fuel stabiliser to the fuel tank and then add fresh fuel up to the tank's maximum capacity (see *Checking and Adding Fuel*). Follow the manufacturer's recommendation for correct amount of stabiliser to add.
3. Start the generator and then run it for 10 minutes to ensure that treated fuel is distributed throughout the engine's fuel system. Then stop the generator and turn the fuel shutoff valve to the **OFF** position.
4. Allow the unit to cool down and then move it to a clean, dry place for storage.
5. For electric-start models equipped with a 12 Volt battery, the battery should be re-charged at intervals of no more than 3 months (see *12 Volt Battery Maintenance*).

Storage Procedure for Greater than 3 Months

1. Clean the generator as outlined in *Cleaning the Generator*.
2. Drain the fuel (see *Draining the Fuel*).
3. Change the engine oil (see *Changing Engine Oil*).
4. Remove the spark plug (see *Spark Plug Maintenance*) and pour a tablespoon of clean engine oil into the spark plug opening. While placing a clean rag over the spark plug opening, slowly pull the recoil starter handle to rotate the engine several times. This will distribute the oil and protect the cylinder wall from corrosion during storage.
5. Re-install the spark plug (see *spark Plug Maintenance*).
6. Move the generator to a clean, dry place for storage.
7. For electric-start models equipped with a 12 Volt battery, the battery should be re-charged at intervals of no more than 3 months (see *12 Volt Battery Maintenance*).

Removal from Storage

Follow the normal procedures for pre-operation checks and starting (see *Before Starting the Generator*).

Use only fresh fuel to re-fill the tank, if necessary, rather than re-using the old fuel.

If oil was inserted into the cylinder prior to storage, the exhaust may smoke for a short while after starting the generator; this is normal and will cease within a minute or so of running time.

DISMANTLING AND DISPOSAL

There is no requirement for the generator to be dismantled during normal operation other than for major repair/overhaul or prior to final disposal at the end of its service life.

Dismantling should only be carried out by a mechanically proficient person with access to proper tools or alternatively by your authorised Westinghouse service dealer for a fee.

Before dismantling:

1. Stop the generator (see *Stopping the Generator*).
2. Drain the engine oil (see *Changing Engine Oil*).
3. Drain the fuel (see *Draining the Fuel*).
4. Disconnect and remove the battery, if so equipped (see *12 Volt Battery Maintenance*).

NOTICE

Do not pollute the environment by improper or illegal disposal of the waste fluids or 12 Volt battery. Dispose of these hazardous items only at an authorised waste collection/recycling facility.

Do not pollute the environment by improper or illegal disposal of the generator either as a whole or in parts. Take the unwanted unit or components to your local recycling centre instead. The generator is made almost entirely of metal that can be recycled.



TROUBLESHOOTING

⚠ WARNING



Before attempting to service or troubleshoot the generator, the owner or service technician must first read and understand the instruction manual and comply with all safety instructions. Failure to follow all instructions may result in conditions leading to voiding of the product warranty, serious personal injury, property damage or even death.

PROBLEM	POTENTIAL CAUSE	SOLUTION
Electric starter will not crank engine fast enough or at all (electric start models only).	1. Electrical load connected to generator.	1. Switch main 240-Volt AC circuit breaker and individual 240-Volt AC outlet circuit breakers (if so equipped) to the OFF position. Unplug any electrical cords or devices from the 240-Volt AC receptacle(s).
	2. Flat battery.	2. Start engine manually or recharge battery using an external battery charger.
	3. Faulty battery.	3. Replace battery.
	4. If above possible causes are checked and eliminated, generator may be faulty.	4. Take generator to an authorised Westinghouse service dealer.
Engine will not start or starts and runs rough.	1. Engine control switch is in the STOP position.	1. Push engine control switch into the RUN position.
	2. Electrical load connected to generator.	2. Switch main 240-Volt AC circuit breaker and individual 240-Volt AC outlet circuit breakers (if so equipped) to the OFF position. Unplug any electrical cords or devices from the 240-Volt AC receptacle(s).
	3. Generator is out of fuel.	3. Check fuel level and add fuel if necessary.
	4. Fuel is stale or contaminated with water or other foreign substance.	4. Drain fuel and refill with fresh fuel.
	5. Fuel shutoff valve is in the OFF position.	5. Move fuel shutoff valve to the ON position.
	6. Engine is not choked (if cold).	6. Move choke lever to the ON position. Not applicable to the WHXC8500E-AS unless its 12 Volt battery is flat.
	7. Engine is over choked (if warm).	7. Move choke lever either midway between the ON and OFF positions or fully to the OFF position. Not applicable to the WHXC8500E-AS unless its 12 Volt battery is flat.
	8. Fuel sediment cup filter is dirty or blocked.	8. Check fuel sediment cup/filter and clean if necessary.
	9. Air filter is dirty or blocked.	9. Check air filter element and clean if necessary.
	10. Spark plug boot is not properly connected onto spark plug terminal.	10. Push spark plug boot firmly onto spark plug.
	11. Spark plug is dirty or faulty.	11. Clean or replace spark plug.
	12. Low oil level.	12. Check oil level and add oil if necessary.
	13. Spark arrester is dirty or blocked.	13. Check spark arrester and clean if necessary.
	14. If above possible causes are checked and eliminated, generator may be faulty.	14. Take generator to an authorised Westinghouse service dealer.

TROUBLESHOOTING

PROBLEM	POTENTIAL CAUSE	SOLUTION
Engine is running, but no 240-Volt AC output is available.	1. If VFT meter display is blank, generator may be faulty.	1. Take generator to an authorised Westinghouse service dealer.
	2. Main 240-Volt AC circuit breaker or individual 240-Volt AC outlet circuit breakers (if so equipped) are in the OFF position.	2. Switch main 240-Volt AC circuit breaker and individual 240-Volt AC outlet circuit breakers (if so equipped) to the ON position.
	3. RCD safety switch circuit breaker (if so equipped) is in the OFF position.	3. Move RCD safety switch circuit breaker (if so equipped) to the ON position.
	4. Connected electrical cord or device plug is not properly inserted into 240-Volt AC outlet socket.	4. Check connected electrical cord or appliance plug is fully inserted into the 240-Volt AC outlet socket.
	5. Connected electrical cord or device is faulty.	5. Connect known functioning device directly into generator's 240-Volt AC outlet socket to verify electrical output.
	6. WHXC8500E-AS: In auto-start mode with 2-wire remote control, there is no 240 V AC output for 15 seconds after a "start" command and 7 seconds after a "stop" command.	6. This is normal operation. No fault.
	7. If above possible causes are checked and eliminated, generator may be faulty.	7. Take generator to an authorised Westinghouse service dealer.
Engine is running, but no 12-Volt DC output is available.	1. 12-Volt DC circuit breaker is in the OFF position.	1. Switch 12-Volt DC circuit breaker to the ON position.
	2. Connected electrical cord or device plug is not properly inserted into 12-Volt DC outlet socket.	2. Check connected electrical cord or device plug is fully inserted into the 12-Volt DC outlet socket.
	3. Connected electrical cord or device is faulty.	3. Connect known functioning device directly into generator's 12-Volt DC outlet socket to verify electrical output.
	4. WHXC8500E-AS: In auto-start mode with 2-wire remote control, there is no 12 V DC output for 15 seconds after a "start" command and 7 seconds after a "stop" command.	4. This is normal operation. No fault.
	5. If above possible causes are checked and eliminated, generator may be faulty.	5. Take generator to an authorised Westinghouse service dealer.

TROUBLESHOOTING

PROBLEM	POTENTIAL CAUSE	SOLUTION
Engine stops during operation.	1. Generator is out of fuel.	1. Check fuel level and add fuel if necessary.
	2. Fuel is contaminated with water or other foreign substance.	2. Drain fuel and refill with fresh fuel.
	3. Low oil level.	3. Check oil level and add oil if necessary.
	4. Overload or short circuit in the 240-Volt AC system.	4. Disconnect all electrical cords and devices from generator and switch all AC circuit breakers OFF . Re-start generator and then re-connect electrical loads individually if possible. Check running and starting power demands of total connected electrical load versus generator's rating.
	5. WHXC8500E-AS: In auto-start mode with 2-wire remote control, the generator receives a "stop" command by opening of the 2-wire remote control circuit.	5. This is normal operation. No fault.
	6. If above possible causes are checked and eliminated, generator may be faulty.	6. Take generator to an authorised Westinghouse service dealer.
Engine runs erratically or does not hold steady speed.	1. Engine is not warm enough.	1. Disconnect all electrical cords and appliances from generator and switch all AC circuit breakers OFF . Re-start generator and allow to run for at least 2 minutes after choke lever has been moved to the OFF position before reconnecting electrical loads.
	2. Choke lever is in the ON position and engine is already warm or hot.	2. Move the choke lever to the OFF position. Not applicable to the WHXC8500E-AS, which has an automatic choke.
	3. Fuel is stale or contaminated.	3. Drain fuel and refill with fresh fuel.
	4. Air filter is dirty or blocked.	4. Check air filter element and clean if necessary.
	5. Electrical load cycling on and off.	5. Engine speed may vary slightly when electrical load changes; this is normal operation. No fault.
	6. If above possible causes are checked and eliminated, generator may be faulty.	6. Take generator to an authorised Westinghouse service dealer.
The engine emits a metallic "pinging" sound.	1. This sound may be heard occasionally when the generator is operating under heavy load.	1. This is normal operation. No fault.
	2. If this sound is heard frequently when the generator is operating under normal load: (a) the fuel may be unsuitable or contaminated, or (b) the spark plug may be unsuitable or fouled.	2. (a) Drain fuel and refill with fresh fuel of the correct type from a known source. (b) Replace spark plug with a new one of the correct type.
	3. If above possible causes are checked and eliminated, generator may be faulty.	3. Take generator to an authorised Westinghouse service dealer.
RCD safety switch turns itself OFF (if so equipped).	1. Electrical fault in connected cord(s) or device(s).	1. Disconnect all electrical cords and devices from generator and switch all 240-Volt AC circuit breakers OFF . Reset RCD safety switch to ON position. Reconnect and test run 240-Volt AC loads individually. Any faulty cord or device that trips the RCD safety switch again must not be used further until checked and approved by a licensed electrician.

TROUBLESHOOTING

PROBLEM	POTENTIAL CAUSE	SOLUTION
RCD safety switch turns itself OFF (if so equipped).	2. Generator is connected to a fixed multiple earthed neutral (MEN) electrical installation.	2. Disconnect the generator from the MEN electrical installation and instead power the electrical device(s) by detachable plug and socket-outlet connection.
	3. If above possible causes are checked and eliminated, generator may be faulty.	3. Take generator to an authorised Westinghouse service dealer.
Main 240V-AC circuit breaker turns itself off.	1. Electrical overload or short circuit in connected cord(s) or device(s).	1. Disconnect all electrical cords and devices from generator and switch all 240-Volt AC circuit breakers OFF . Check RCD safety switch is in ON position (if so equipped). Reconnect and test run 240-Volt AC loads individually. Any single cord or device that trips the main circuit breaker again is either faulty or too great a load for the generator. Any faulty electrical device must not be used further until checked and approved by a licensed electrician. Check running and starting power demands of total connected electrical load versus generator's rating.
	2. If above possible cause is checked and eliminated, generator may be faulty.	2. Take generator to an authorised Westinghouse service dealer.
Individual 240V-AC outlet circuit breaker turns itself off (if so equipped).	1. Electrical overload or short circuit in connected cord(s) or devices(s).	1. Disconnect all electrical cords and devices from generator and switch all 240-Volt AC circuit breakers OFF . Check RCD safety switch is in ON position (if so equipped). Reconnect and test run 240-Volt AC loads individually. Any single cord or device that trips the individual circuit breaker again is either faulty or too great a load for the circuit. Any faulty electrical device must not be used further until checked and approved by a licensed electrician. Check running and starting power demands of total connected electrical load versus the generator's or outlet's rating (whichever is the lesser).
	2. If above possible cause is checked and eliminated, generator may be faulty.	2. Take generator to an authorised Westinghouse service dealer.
12V-DC circuit breaker turns itself OFF .	1. Electrical overload or short circuit in connected cord or devices.	1. Disconnect any electrical cord or device from 12-Volt DC accessory socket. Reset 12-Volt DC circuit breaker to ON position. Reconnect and test run 12-Volt DC cord or device. Any cord or device that trips the circuit breaker again is either faulty or too great a load for the circuit. Any faulty electrical device must not be used further until checked and approved by a licensed electrician. Check running power demand of total connected electrical load versus the outlet's rating.
	2. If above possible cause is checked and eliminated, generator may be faulty.	2. Take generator to an authorised Westinghouse service dealer.
The VFT meter displays steady state voltage of less than 228 V or greater than 252 V when operating under load.	1. The generator may be faulty.	1. Take generator to an authorised Westinghouse service dealer.
The VFT meter displays steady state frequency of less than 47 Hz or greater than 53 Hz when operating under load.	1. Engine speed is incorrect.	1. Check and adjust engine speed. Refer to the Technical Guide available for download from www.westinghouseoutdoorpower.com.au .
	2. The generator may be faulty.	2. Take generator to an authorised Westinghouse service dealer.



SPECIFICATIONS

	PARAMETER	WHXC3750	WHXC3750-PRO	WHXC5000	WHXC7000	WHXC8500E WHXC8500E-AS	WHXC8500E-PRO
ENGINE	Type	1-Cylinder, 4-Stroke, Overhead Valve, Air Cooled					
	Displacement (cm ³)	208	208	292	357	420	420
	Speed (rpm)	3,000	3,000	3,000	3,000	3,000	3,000
	Oil Capacity (L)	0.6	0.6	1	1	1	1
	Low Oil Shutdown	Yes	Yes	Yes	Yes	Yes	Yes
	Spark Plug	Torch F6RTC					
	Fuel	Unleaded Petrol	Unleaded Petrol	Unleaded Petrol	Unleaded Petrol	Unleaded Petrol	Unleaded Petrol
	Fuel Tank Capacity (L)	15	15	25	25	25	25
	Fuel Gauge	Yes	Yes	Yes	Yes	Yes	Yes
	Starting Method	Recoil	Recoil	Recoil	Recoil	Electric and Recoil	Electric and Recoil
	Battery Included	No	No	No	No	Yes	Yes
	2-Wire Remote Control	No	No	No	No	8500E: No 8500E-AS: Yes	No
240 V AC ELECTRICAL	Voltage (V) / Frequency (Hz)	240 / 50	240 / 50	240 / 50	240 / 50	240 / 50	240 / 50
	Number of Phases	1	1	1	1	1	1
	Continuous Running Power (W) *	3,000	3,000	4,000	5,500	6,750	6,750
	Maximum Starting Power (W)	3,750	3,750	5,000	7,000	8,500	8,500
	Continuous Running Current (A)	12.5	12.5	16.7	22.9	28.1	28.1
	Voltage Control	Automatic Voltage Regulator (AVR), Sine Wave Output					
	Receptacles	2 x 15 A, IP44	1 x 15 A, IP66	2 x 15 A, IP44	2 x 15 A, IP44	2 x 15 A, IP44	2 x 15 A, IP66
	Overload Protection	Circuit Breaker	Circuit Breaker	Circuit Breaker	Circuit Breaker	Circuit Breaker	Circuit Breaker
	RCD Safety Switch	No	Yes	No	No	No	Yes
	Digital VFT Meter	Yes	Yes	Yes	Yes	Yes	Yes
12 V DC ELECTRICAL	Voltage (V)	12	12	12)	12	12	12
	Maximum Current (A)	8.3	8.3	8.3	8.3	8.3	8.3
	Maximum Power (W)	100	100	100	100	100	100
	Receptacle	8.3 A, IP44	8.3 A, IP44	8.3 A, IP44	8.3 A, IP44	8.3 A, IP44	8.3 A, IP44
	Overload Protection	Circuit Breaker	Circuit Breaker	Circuit Breaker	Circuit Breaker	Circuit Breaker	Circuit Breaker
ACCESS.	Wheel & Handle Kit	Included	Included	Included	Included	Included	Included
	Engine Oil & Funnel	Included	Included	Included	Included	Included	Included
	Spark Plug Socket Wrench	Included	Included	Included	Included	Included	Included
DIMENSIONS & WEIGHT	Length (mm)	645	645	735	735	735	735
	Width (mm)	600	600	700	700	700	700
	Height (mm)	555	555	655	655	655	655
	Weight - Dry (kg)	52	52	71	80	94	94
	Weight - Wet (kg)	64	64	90	99	113	113

* Rated output at 1.0 power factor.



WHXC3750 WIRING DIAGRAM

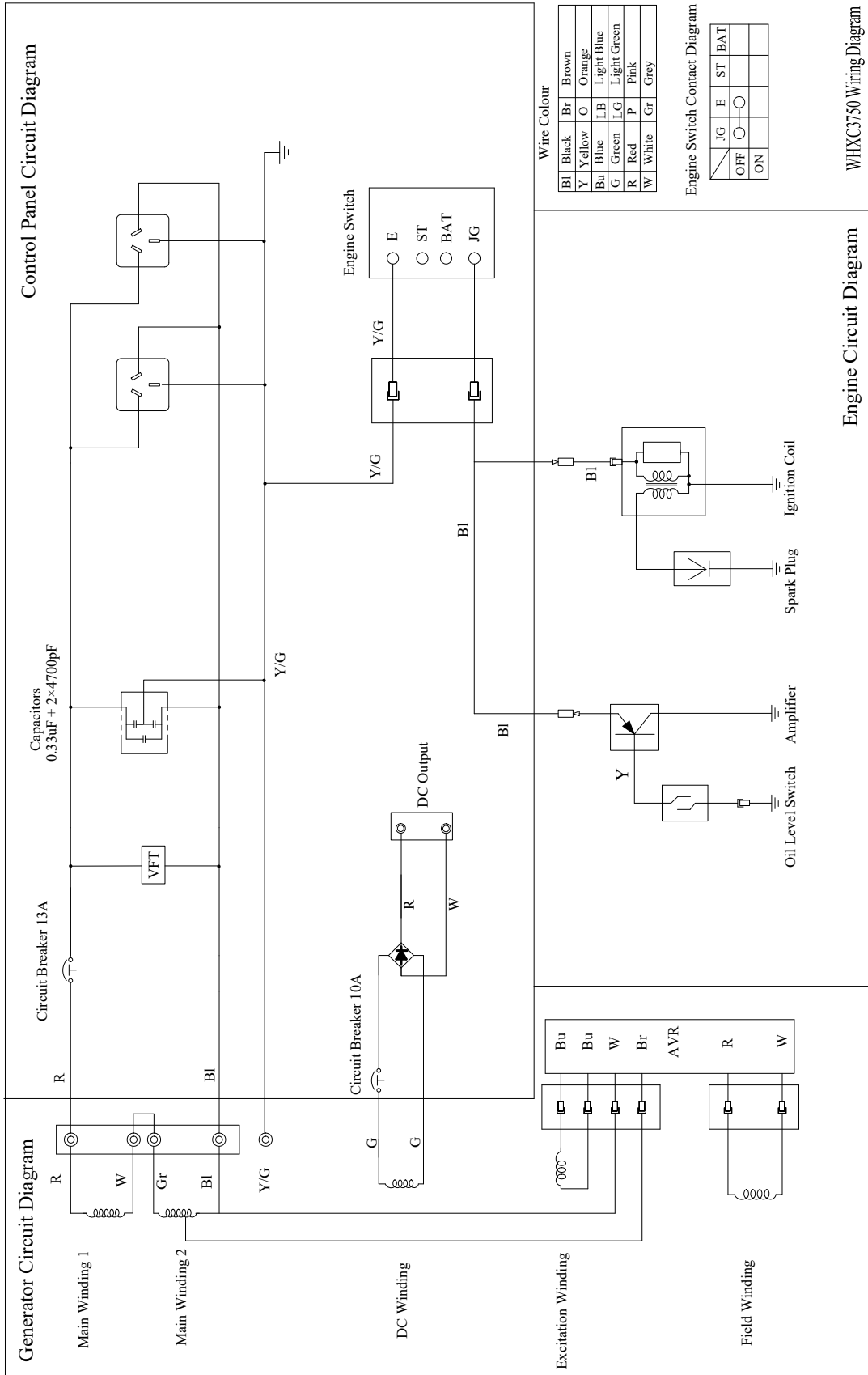

WHXC3750 Wiring Diagram

Engine Circuit Diagram

WIRING DIAGRAMS

WHXC3750-PRO WIRING DIAGRAM

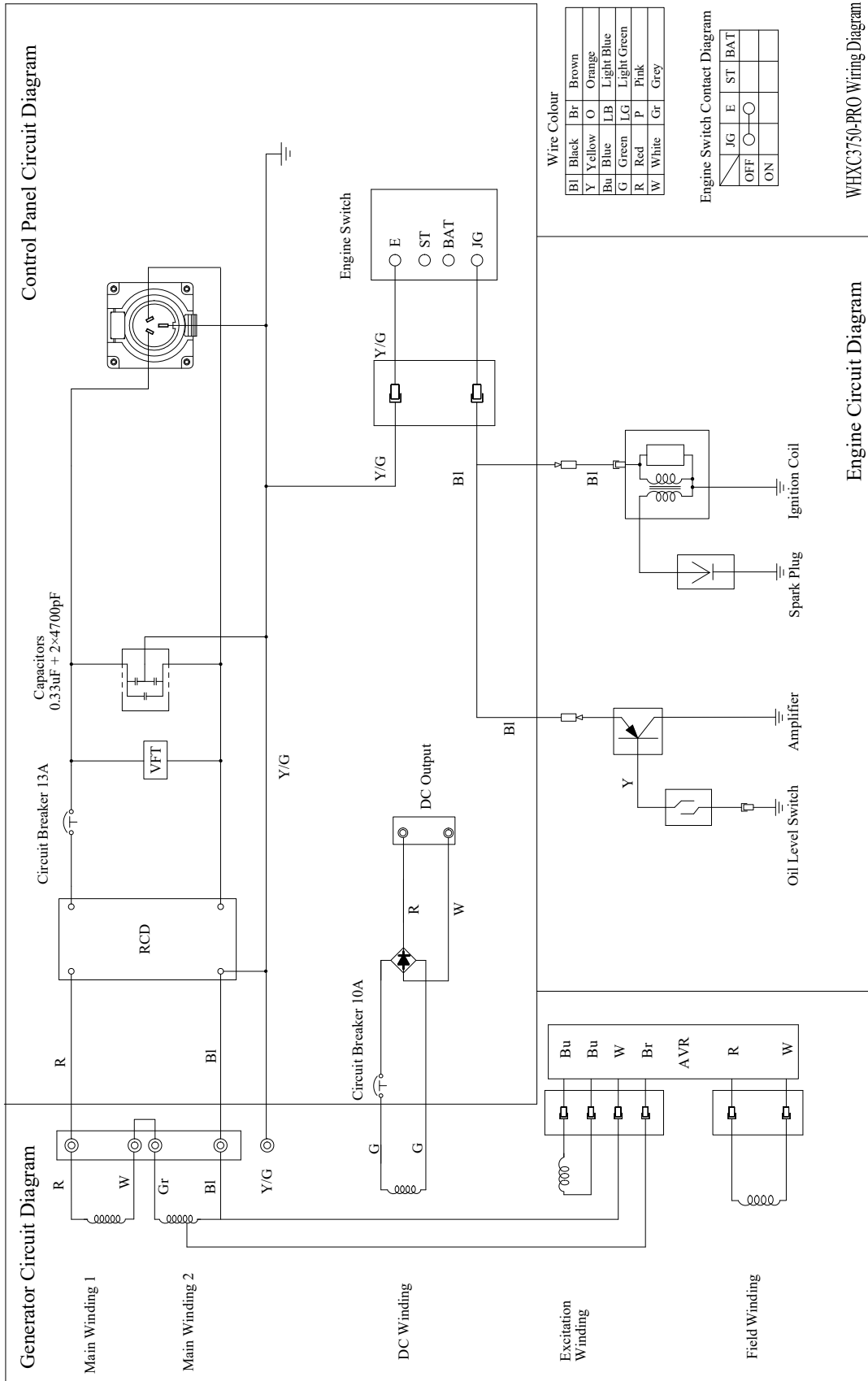

WHXC3750-PRO Wiring Diagram

Engine Circuit Diagram

Control Panel Circuit Diagram

Generator Circuit Diagram

WHXC5000 WIRING DIAGRAM

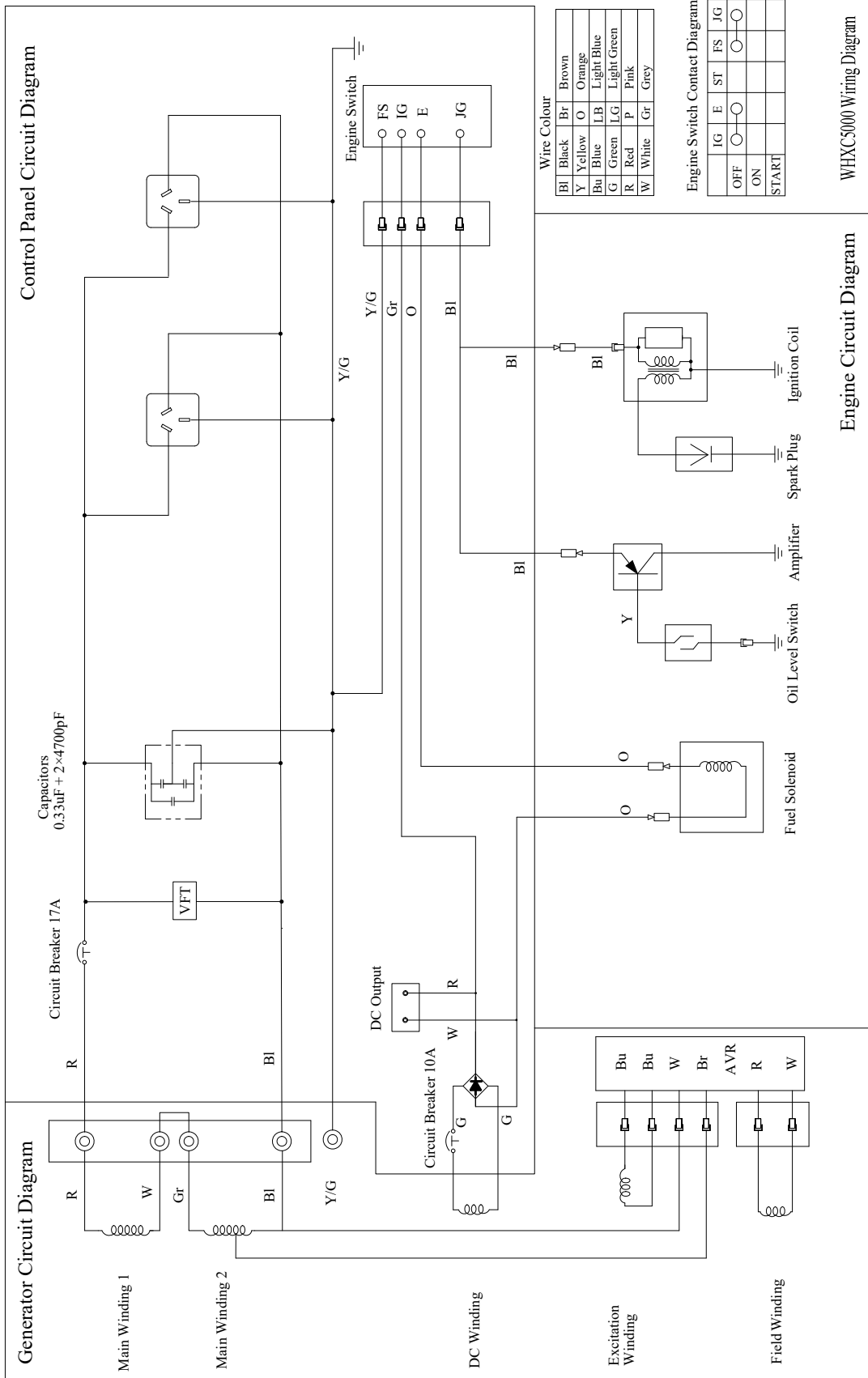

WHXC5000 Wiring Diagram

Engine Circuit Diagram

WIRING DIAGRAMS

WHXC7000 WIRING DIAGRAM

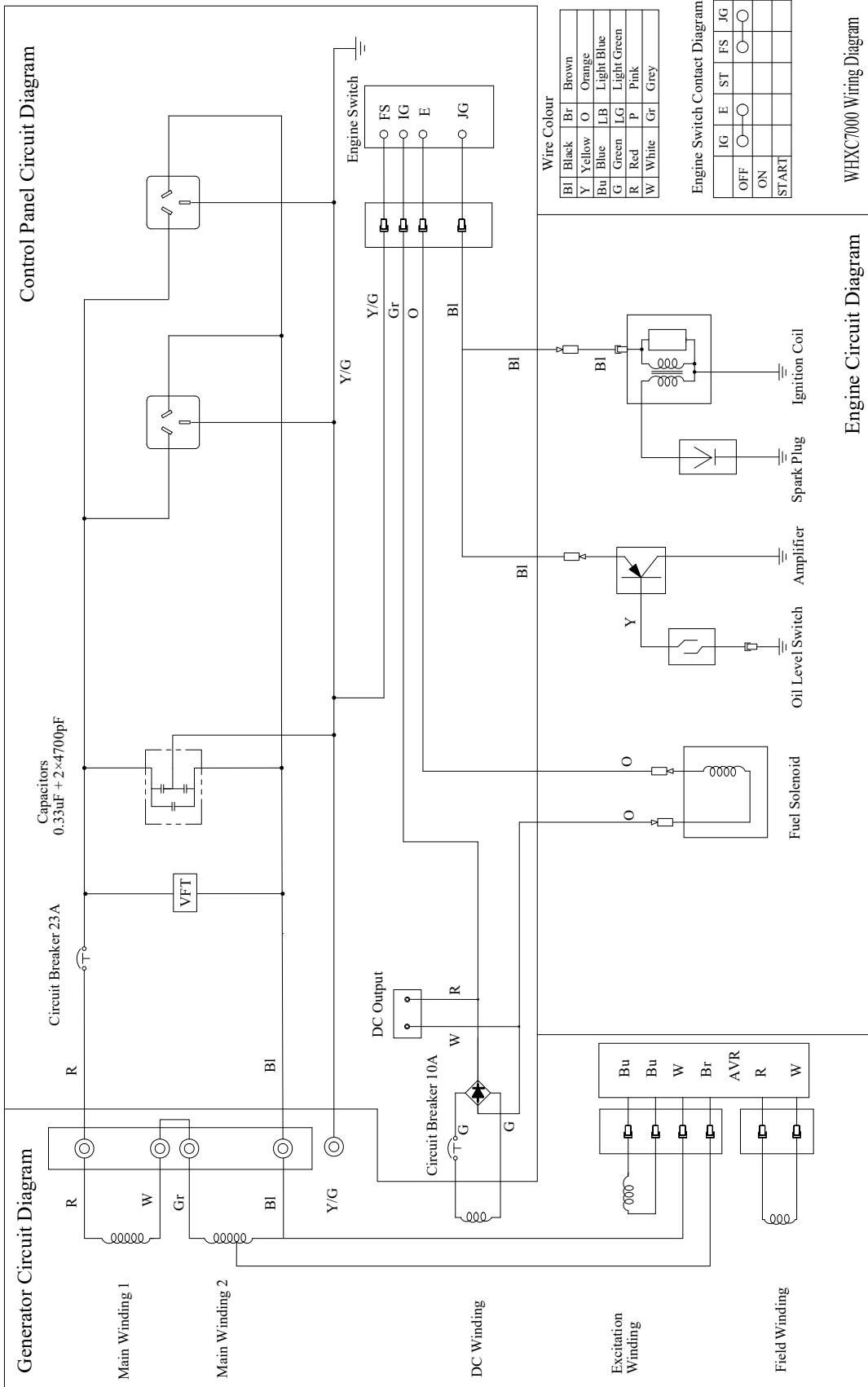

WHXC7000 Wiring Diagram

Engine Circuit Diagram

WHXC8500E WIRING DIAGRAM

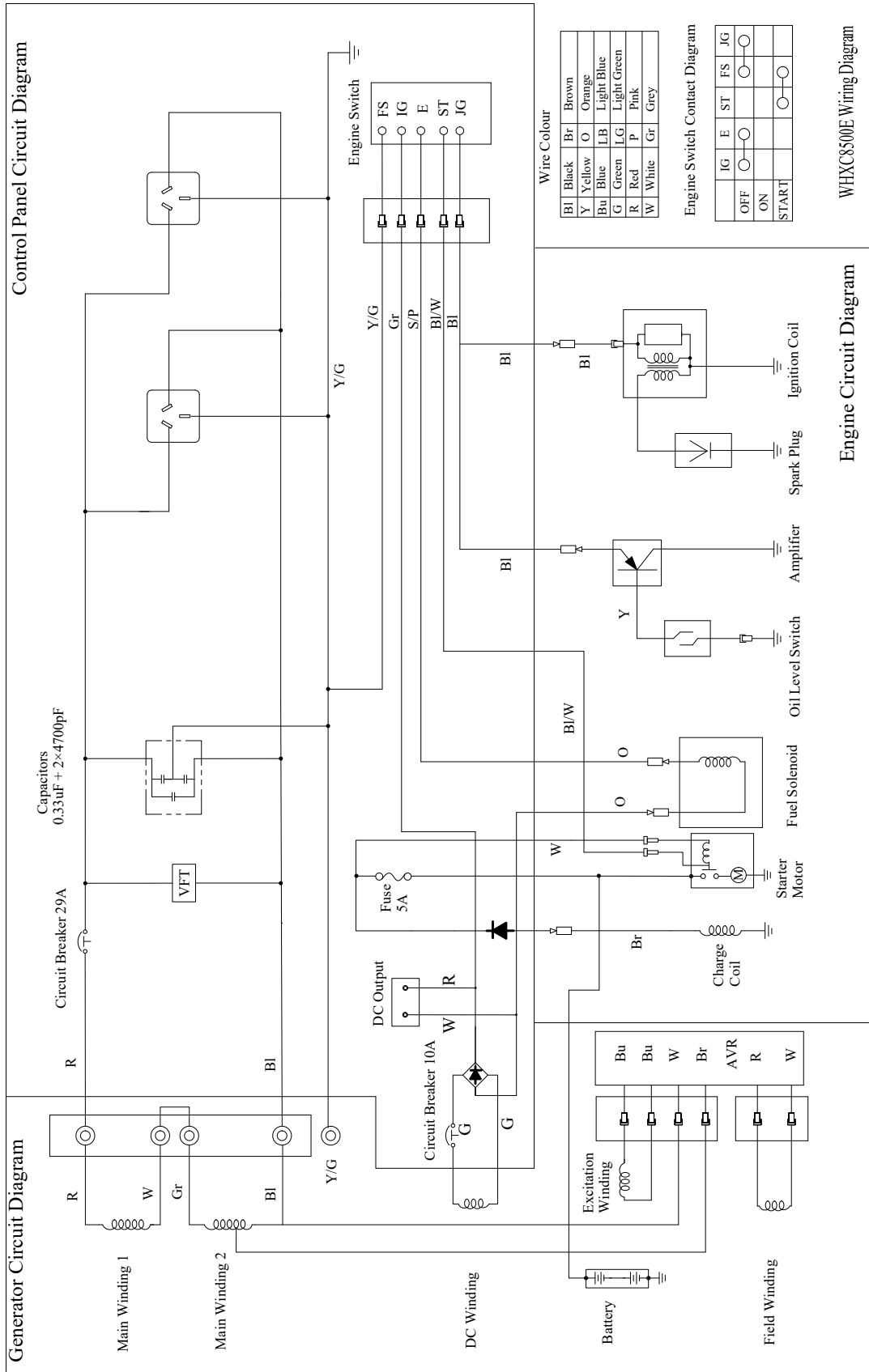

WHXC8500E Wiring Diagram

Engine Circuit Diagram

WIRING DIAGRAMS

WHXC8500E-PRO WIRING DIAGRAM

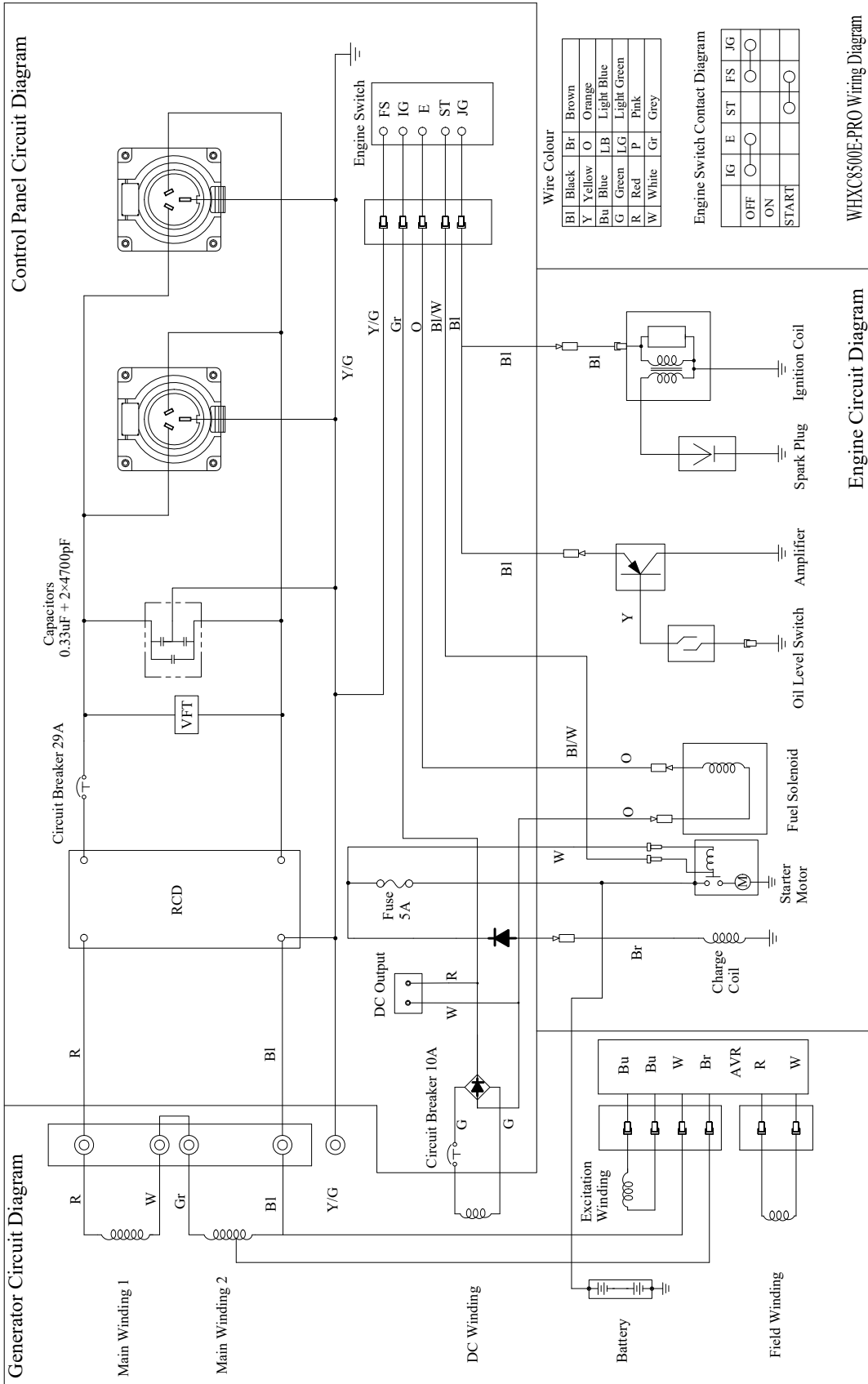

WHXC8500E-PRO Wiring Diagram

Engine Circuit Diagram

WHXC8500E-AS WIRING DIAGRAM

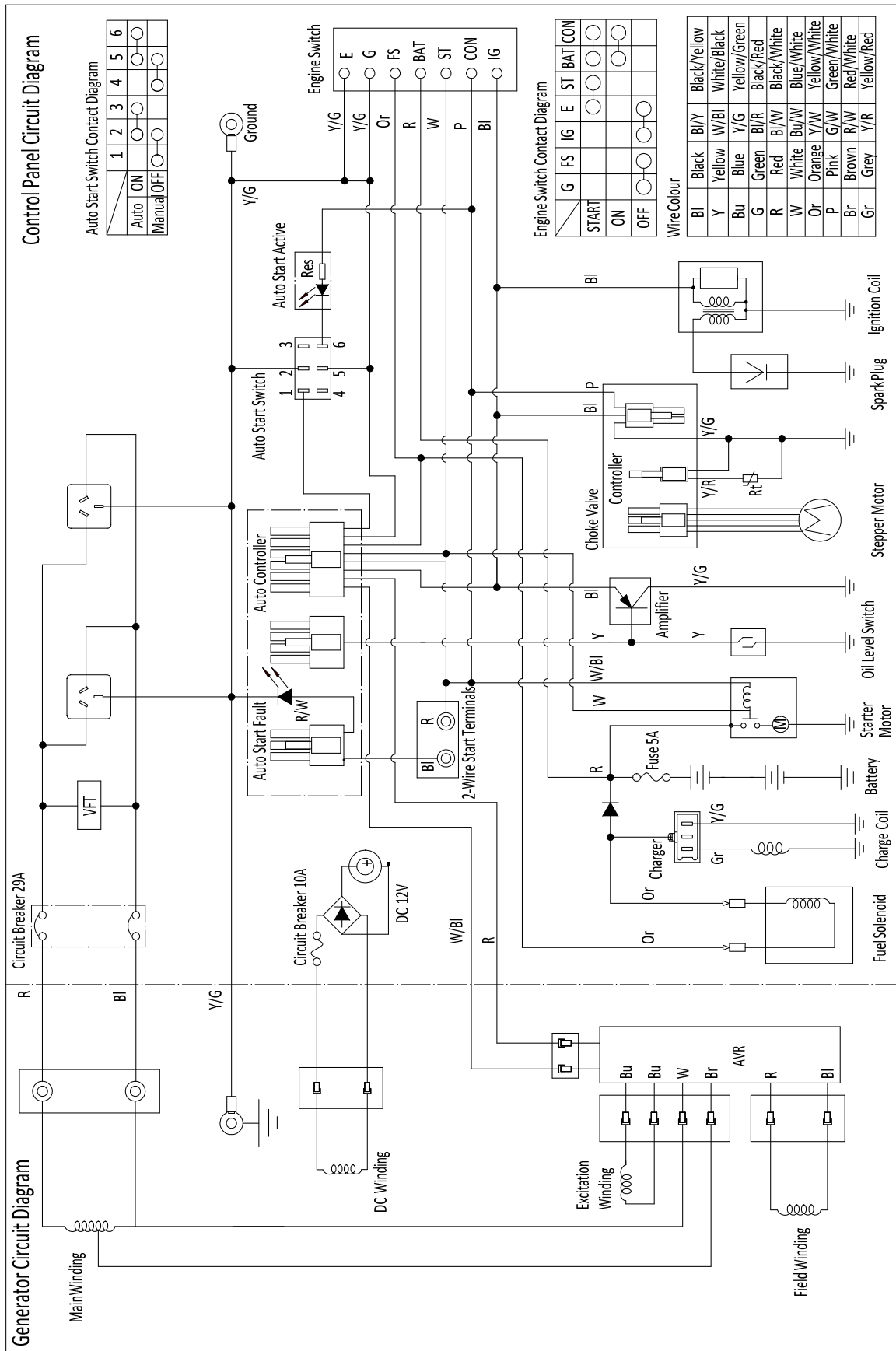

WARRANTY

WARRANTY AGAINST DEFECTS

Proof of Purchase

It is recommended that you keep a copy of the original tax invoice for your records.

Warrantor

Name: Westinghouse Outdoor Power Equipment
(ABN 21101370085)

Address: 21 Resource Street,
Parkinson, 4115, Australia

Phone: (1800) 453 626

Email: info@wpowereq.com.au

Web: westinghouseoutdoorpower.com.au

Warranty Conditions

Westinghouse Outdoor Power Equipment (the “Company”) warrants that its Westinghouse portable electric generators (the “Goods”) shall be free from defects in material and workmanship for a period of two years (2) years or five hundred (500) operating hours, whichever occurs first, from the date of original sale (hereinafter the “Warranty Period”) in normal domestic applications such as personal, residential household or recreational use.

A Warranty Period of one (1) year or five hundred (500) operating hours, whichever occurs first, shall apply in commercial applications such as income producing, rental or other business-related use. Goods sold to a Consumer with an Australian Business Number shall be deemed as being used in a commercial application.

The Warranty Period is continuous from the date of original sale and does not restart upon the repair or replacement of the Goods or any part thereof.

Upon return – transportation charges prepaid by the Consumer – to the Company’s or its nominated dealer’s premises within the Warranty Period, the Company shall repair or replace, at its option, any Goods which it determines to contain defective material or workmanship, and shall return said Goods to the Consumer free-on-board (FOB) at the Company’s or agent’s premises. The repair or replacement work will be scheduled and performed according to the Company’s normal work flow and availability of replacement parts.

The Company shall not be obligated, however, to repair or replace Goods which have been: repaired by others; abused; improperly installed, operated, maintained, repaired, transported or stored; not

serviced to schedule using genuine spare parts; altered or otherwise misused or damaged in any way.

The Company shall not be responsible for any diagnosis, communication, dismantling, packing, handling, freight, and reassembly or reinstallation charges.

Freight damage, pre-delivery service, normal operating adjustments, preventative maintenance service, consumable items, cosmetic damage, corrosion, erosion, normal wear and tear, performance, merchantability, and fitness for a particular purpose are not covered under this Warranty. Consumable items include batteries, filters, fuel, lubricants and spark plugs.

The Company shall not be liable for any repairs, replacements, or adjustments to the Goods or any costs of labour performed by the Consumer or others without the Company’s prior written approval.

To the extent permissible by law and notwithstanding any other clause in these Warranty Conditions, the Company excludes all liability whatsoever to the Consumer arising out of or in any way connected with a contract for any consequential or indirect losses of any kind howsoever arising and whether caused by breach of statute, breach of contract, negligence or other tort.

The Company’s liability will be limited to, in the case of products, the replacement of the products, the supply of equivalent products or the payment of the cost of replacing the products or of acquiring equivalent products or, in the case of services, the supply of the services again or the payment of the cost of having the services supplied again. The choice of remedy will be at the discretion of the Company and the Consumer acknowledges that this limitation of liability is fair and reasonable.

This Warranty is available only to the original Consumer bearing the original tax invoice from the Company or one of its authorised dealers as proof of purchase. Goods purchased from any other party such as a private seller, auction house, eBay seller, etc. are not covered by this Warranty.

Our Goods come with guarantees that cannot be excluded under the Australian Consumer Law. You are entitled to a replacement or refund for a major failure and compensation for any other reasonably foreseeable loss or damage. You are also entitled to have the Goods repaired or replaced if the Goods fail to be of acceptable quality and the failure does not amount to a major failure.





Westinghouse

INNOVATION YOU CAN BE SURE OF

Westinghouse Outdoor Power Equipment

21 Resource Street
Parkinson QLD 4115 Australia
westinghouseoutdoorpower.com.au

© 2019 All rights reserved. Content may change without notice.
Ⓜ, Westinghouse, and INNOVATION YOU CAN BE SURE OF
are trademarks of the Westinghouse Electric Corporation used
under license by Westinghouse Outdoor Power Equipment, LLC.
All rights reserved.

2020-05-14